

# SERVICE MANUAL

# BA-5 CHASSIS

Self Diagnosis  
Supported model

<u>MODEL</u>	<u>COMMANDER</u>	<u>DEST</u>	<u>CHASSIS NO.</u>
<b>KV-24FV12</b>	RM-Y168	US	SCC-S40C-A
<b>KV-24FV12</b>	RM-Y168	CND	SCC-S41C-A
<b>KV-25FV12</b>	RM-Y168	E	SCC-S38G-A
<b>KV-25FV12A</b>	RM-Y168	E	SCC-S38H-A
<b>KV-25FV12C</b>	RM-Y168	E	SCC-S38J-A



KV-25FV12A



RM-Y168

TRINITRON® COLOR TV  
**SONY**®

<b>SPECIFICATIONS</b>
-----------------------

	KV-24FV12	KV-25FV12 KV-25FV12A KV-25FV12C
Power requirements	120V, 60Hz	120-220V, 50/60Hz
Number of inputs/outputs		
Video <sup>1)</sup>	2	2
S Video <sup>2)</sup>	1	1
Audio <sup>3)</sup>	2	2
Audio Out <sup>4)</sup>	1	1
Headphone Out <sup>4)</sup>	1	1
Speaker output(W)	10W x 2	10W x 2
Power Consumption(W)		
In use(Max)	150W	150W
In standby	1W	1W
Dimensions(W/H/D)		
(mm)	652 x 524.3 x 467.3mm	652 x 524.3 x 467.3mm
(in)	25 <sup>2/3</sup> x 20 <sup>2/3</sup> x 18 <sup>5/12</sup>	25 <sup>2/3</sup> x 20 <sup>2/3</sup> x 18 <sup>5/12</sup>
Mass		
(kg)	37kg	37kg
(lbs)	81 lbs 9oz	81 lbs 9oz

- 1) 1 Vp-p 75 ohms unbalanced, sync negative
- 2) Y: 1 Vp-p 75 ohms unbalanced, sync negative  
C: 0.286 Vp-p (Burst signal), 75 ohms
- 3) 500mVrms (100% modulation), impedance: 47kilohms
- 4) More than 408 mVrms at the maximum volume setting (variable)  
More than 408 mVrms (fix)

**Television system**

American TV standard/NTSC  
PAL M, N (KV-25FV12A ONLY)

**Channel coverage**

VHF:2-13/UHF:14-69/CATV:1-125

**Visible screen size**

24" picture measured diagonally

**Actual screen size**

25" picture measured diagonally

**Antenna**

75 ohm external antenna terminal for VHF/UHF

**Supplied accessories**

Remote Commander RM-Y168  
Size AA (R6) batteries (2)

**Optional accessories**

Connecting cables: VMC-810S/820S, VMC-720M,  
YC-15V/30V, RK74A  
U/V mixer EAC-66

*Design and specifications are subject to change without notice.*

<b>TABLE OF CONTENTS</b>
--------------------------

<i>Section</i>	<i>Title</i>	<i>Page</i>
	Warnings and Cautions .....	4
	Self-Diagnostic Function .....	4
	Safety Check-Out Instructions .....	7
<b>1.</b>	<b>GENERAL</b> .....	<b>8</b>
<b>2.</b>	<b>DISASSEMBLY</b>	
2-1.	Rear Cover Removal .....	13
2-2.	Chassis Assembly Removal .....	13
2-3.	Service Position .....	13
2-4.	Picture Tube Removal .....	14
<b>3.</b>	<b>SET-UP ADJUSTMENTS</b>	
3-1.	Beam Landing .....	15
3-2.	Convergence .....	16
3-3.	Focus .....	17
3-4.	Screen (G2) .....	17
3-5.	Method of Setting the Service Adjustment Mode .....	18
3-6.	White Balance Adjustments .....	18
<b>4.</b>	<b>SAFETY RELATED ADJUSTMENTS</b>	
4-1.	☒ R564 Confirmation Method (HV Hold-Down Confirmation and Readjustments) .....	19
4-2.	B+ Voltage Confirmation and Adjustment .....	19
<b>5.</b>	<b>CIRCUIT ADJUSTMENTS</b>	
5-1.	Setting the Service Adjustment Mode .....	21
5-2.	Memory Write Confirmation Method .....	21
5-3.	Adjustment Buttons and Indicators .....	21
5-4.	A Board Adjustments .....	23
<b>6.</b>	<b>DIAGRAMS</b>	
6-1.	Block Diagram .....	27
6-2.	Circuit Board Location .....	31
6-3.	Printed Wiring Boards and Schematic Diagrams .....	31
	• A Board .....	33
	• MB Board .....	39
	• CB Board .....	45
	• HZ Board .....	46
	• K Board .....	47
	• VB Board .....	48
6-4.	Semiconductors .....	49
<b>7.</b>	<b>EXPLODED VIEW</b>	
7-1.	Chassis (KV-24FV12 ONLY) .....	50
7-2.	Chassis (KV-25FV12A ONLY) .....	51
7-3.	Chassis (KV-25FV12/25FV12C ONLY) .....	52
<b>8.</b>	<b>ELECTRICAL PARTS LIST</b> .....	<b>53</b>

## WARNINGS AND CAUTIONS

### CAUTION

SHORT CIRCUIT THE ANODE OF THE PICTURE TUBE AND THE ANODE CAP TO THE METAL CHASSIS, CRT SHIELD, OR CARBON PAINTED ON THE CRT, AFTER REMOVING THE ANODE.

### WARNING!!

AN ISOLATION TRANSFORMER SHOULD BE USED DURING ANY SERVICE TO AVOID POSSIBLE SHOCK HAZARD, BECAUSE OF LIVE CHASSIS. THE CHASSIS OF THIS RECEIVER IS DIRECTLY CONNECTED TO THE AC POWER LINE.

### SAFETY-RELATED COMPONENT WARNING!!

COMPONENTS IDENTIFIED BY SHADING AND MARK  $\triangle$  ON THE SCHEMATIC DIAGRAMS, EXPLODED VIEWS, AND IN THE PARTS LIST ARE CRITICAL FOR SAFE OPERATION. REPLACE THESE COMPONENTS WITH SONY PARTS WHOSE PART NUMBERS APPEAR AS SHOWN IN THIS MANUAL OR IN SUPPLEMENTS PUBLISHED BY SONY. CIRCUIT ADJUSTMENTS THAT ARE CRITICAL FOR SAFE OPERATION ARE IDENTIFIED IN THIS MANUAL. FOLLOW THESE PROCEDURES WHENEVER CRITICAL COMPONENTS ARE REPLACED OR IMPROPER OPERATION IS SUSPECTED.

### ATTENTION!!

APRES AVOIR DECONNECTE LE CAP DE L'ANODE, COURT-CIRCUITER L'ANODE DU TUBE CATHODIQUE ET CELUI DE L'ANODE DU CAP AU CHASSIS METALLIQUE DE L'APPAREIL, OU AU COUCHE DE CARBONE PEINTE SUR LE TUBE CATHODIQUE OU AU BLINDAGE DU TUBE CATHODIQUE.

### ATTENTION!!

AFIN D'EVITER TOUT RESQUE D'ELECTROCUTION PROVENANT D'UN CHÂSSIS SOUS TENSION, UN TRANSFORMATEUR D'ISOLEMENT DOIT ETRE UTILISÉ LORS DE TOUT DÉPANNAGE. LE CHÂSSIS DE CE RÉCEPTEUR EST DIRECTEMENT RACCORDÉ À L'ALIMENTATION SECTEUR.

### ATTENTION AUX COMPOSANTS RELATIFS A LA SECURITE!!

LES COMPOSANTS IDENTIFIES PAR UNE TRAME ET PAR UNE MARQUE  $\triangle$  SUR LES SCHEMAS DE PRINCIPE, LES VUES EXPLOSEES ET LES LISTES DE PIECES SONT D'UNE IMPORTANCE CRITIQUE POUR LA SECURITE DU FONCTIONNEMENT. NE LES REMPLACER QUE PAR DES COMPOSANTS SONY DONT LE NUMERO DE PIECE EST INDIQUE DANS LE PRESENT MANUEL OU DANS DES SUPPLEMENTS PUBLIES PAR SONY. LES REGLAGES DE CIRCUIT DONT L'IMPORTANCE EST CRITIQUE POUR LA SECURITE DU FONCTIONNEMENT SONT IDENTIFIES DANS LE PRESENT MANUEL. SUIVRE CES PROCEDURES LORS DE CHAQUE REMPLACEMENT DE COMPOSANTS CRITIQUES, OU LORSQU'UN MAUVAIS FONCTIONNEMENT SUSPECTE.

## SELF-DIAGNOSTIC FUNCTION

The units in this manual contain a self-diagnostic function. If an error occurs, the STANDBY/TIMER LED will automatically begin to flash. The number of times the LED flashes translates to a probable source of the problem. A definition of the STANDBY/TIMER LED flash indicators is listed in the instruction manual for the user's knowledge and reference. If an error symptom cannot be reproduced, the Remote Commander can be used to review the failure occurrence data stored in memory to reveal past problems and how often these problems occur.

### Diagnostic Test Indicators

When an error occurs, the STANDBY/TIMER LED will flash a set number of times to indicate the possible cause of the problem. If there is more than one error, the LED will identify the first of the problem areas.

Results for all of the following diagnostic items are displayed on screen. No error has occurred if the screen displays a "0".

Diagnostic Item Description	No. of Times STANDBY/TIMER LED Flashes	Self-Diagnostic Display/ Diagnostic Result	Probable Cause Location	Detected Symptoms
Power does not turn on	Does not light	—————	<ul style="list-style-type: none"> <li>• Power cord is not plugged in.</li> <li>• Fuse is burned out. (F601) (A Board)</li> </ul>	<ul style="list-style-type: none"> <li>• Power does not come on.</li> <li>• No power is supplied to the TV.</li> <li>• AC power supply is faulty.</li> </ul>
+B overcurrent (OCP)*	2 times	2:0 or 2:1	<ul style="list-style-type: none"> <li>• H.OUT (Q502) is shorted. (A Board)</li> <li>• IC702 is shorted. (CB Board)</li> </ul>	<ul style="list-style-type: none"> <li>• Power does not come on.</li> <li>• Load on power line is shorted.</li> </ul>
I-Prot	4 times	4:0 or 4:1	<ul style="list-style-type: none"> <li>• +13V is not supplied. (A Board)</li> <li>• IC502 is faulty. (A Board)</li> </ul>	<ul style="list-style-type: none"> <li>• Has entered standby state after horizontal raster.</li> <li>• Vertical deflection pulse is stopped.</li> <li>• Power line is shorted or power supply is stopped.</li> </ul>
IK	5 times	5:0 or 5:1	<ul style="list-style-type: none"> <li>• Video OUT (IC502) is faulty. (A Board)</li> <li>• IC1301 is faulty. (MB Board)</li> <li>• Screen (G2) is improperly adjusted.**</li> </ul>	<ul style="list-style-type: none"> <li>• No raster is generated.</li> <li>• CRT cathode current detection reference pulse output is small.</li> </ul>

\* If a +B overcurrent is detected, stoppage of the vertical deflection is detected simultaneously.

The symptom that is diagnosed first by the microcontroller is displayed on the screen.

\*\* Refer to Screen (G2) Adjustments in Section 3-4 of this manual.

### Display of Standby/Timer LED Flash Count

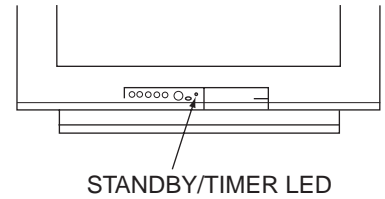
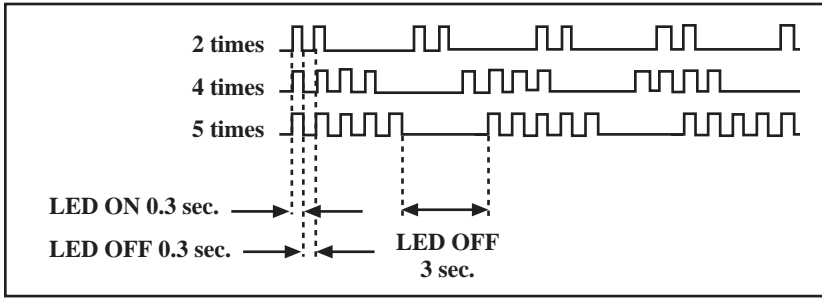

<b>Diagnostic Item</b>	<b>Flash Count*</b>
+B overcurrent	2 times
Vertical deflection stopped	4 times
White balance failure	5 times

\*One flash count is not used for self-diagnostic.

### Stopping the Standby/Timer LED Flash

Turn off the power switch on the TV main unit or unplug the power cord from the outlet to stop the STANDBY/TIMER LAMP from flashing.

### Self-Diagnostic Screen Display

For errors with symptoms such as “power sometimes shuts off” or “screen sometimes goes out” that cannot be confirmed, it is possible to bring up past occurrences of failure on the screen for confirmation.

#### To Bring Up Screen Test

In standby mode, press buttons on the Remote Commander sequentially, in rapid succession, as shown below:

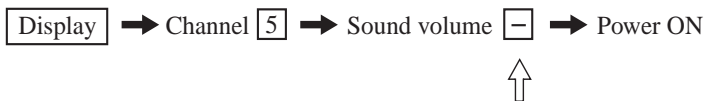

Note that this differs from entering the service mode (sound volume [ + ] ).

#### Self-Diagnostic Screen Display

SELF DIAGNOSTIC		
2:		0
3:	N/A	0
4:		0
5:		1
101:	N/A	0

← Numeral “0” means that no fault was detected.

← Numeral “1” means a fault was detected one time only.

## Handling of Self-Diagnostic Screen Display

Since the diagnostic results displayed on the screen are not automatically cleared, always check the self-diagnostic screen during repairs. When you have completed the repairs, clear the result display to "0".

Unless the result display is cleared to "0", the self-diagnostic function will not be able to detect subsequent faults after completion of the repairs.

### Clearing the Result Display

To clear the result display to "0", press buttons on the Remote Commander sequentially when the diagnostic screen is displayed, as shown below:

Channel **8** → **ENTER**

### Quitting the Self-Diagnostic Screen

To quit the entire self-diagnostic screen, turn off the power switch on the Remote Commander or the main unit.

## Self-Diagnostic Circuit

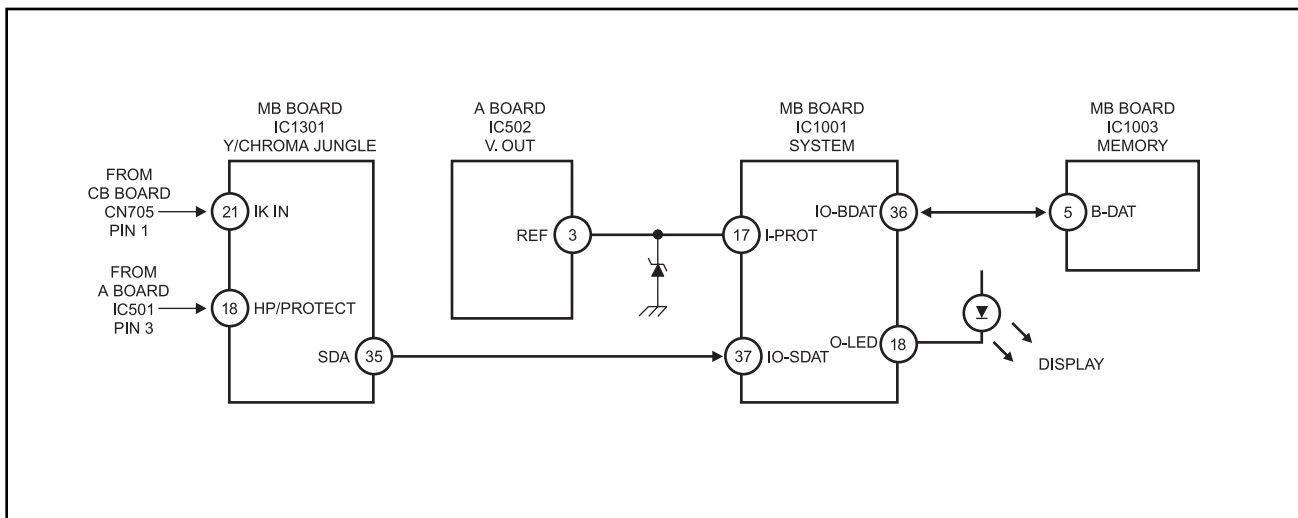

### +B overcurrent (OCP)

Occurs when an overcurrent on the +B (135V) line is detected by pin 18 of IC1301 (MB Board). If the voltage of pin 18 of IC1301 (MB Board) is less than 1V when V.SYNC is more than seven verticals in a period, the unit will automatically turn off.

### I-Prot

Occurs when an absence of the vertical deflection pulse is detected by pin 17 of IC1001 (MB Board). Power supply will shut down when waveform interval exceeds 2 seconds.

### IK

If the RGB levels\* do not balance within 2 seconds after the power is turned on, this error will be detected by IC1301 (MB Board). TV will stay on, but there will be no picture.

\*(Refers to the RGB levels of the AKB detection Ref pulse that detects 1K).

## SAFETY CHECK-OUT

After correcting the original service problem, perform the following safety checks before releasing the set to the customer:

1. Check the area of your repair for unsoldered or poorly soldered connections. Check the entire board surface for solder splashes and bridges.
2. Check the interboard wiring to ensure that no wires are "pinched" or touching high-wattage resistors.
3. Check that all control knobs, shields, covers, ground straps, and mounting hardware have been replaced. Be absolutely certain that you have replaced all the insulators.
4. Look for unauthorized replacement parts, particularly transistors, that were installed during a previous repair. Point them out to the customer and recommend their replacement.
5. Look for parts which, though functioning, show obvious signs of deterioration. Point them out to the customer and recommend their replacement.
6. Check the line cords for cracks and abrasion. Recommend the replacement of any such line cord to the customer.
7. Check the B+ and HV to see if they are specified values. Make sure your instruments are accurate; be suspicious of your HV meter if sets always have low HV.
8. Check the antenna terminals, metal trim, "metallized" knobs, screws, and all other exposed metal parts for AC leakage. Check leakage as described below.

### Leakage Test

The AC leakage from any exposed metal part to earth ground and from all exposed metal parts to any exposed metal part having a return to chassis, must not exceed 0.5 mA (500 microamperes). Leakage current can be measured by any one of three methods.

1. A commercial leakage tester, such as the Simpson 229 or RCA WT-540A. Follow the manufacturers' instructions to use these instructions.
2. A battery-operated AC milliammeter. The Data Precision 245 digital multimeter is suitable for this job.
3. Measuring the voltage drop across a resistor by means of a VOM or battery-operated AC voltmeter. The "limit" indication is 0.75 V, so analog meters must have an accurate low voltage scale. The Simpson's 250 and Sanwa SH-63TRD are examples of passive VOMs that are suitable. Nearly all battery-operated digital multimeters that have a 2 VAC range are suitable (see Figure A).

### How to Find a Good Earth Ground

A cold-water pipe is a guaranteed earth ground; the cover-plate retaining screw on most AC outlet boxes is also at earth ground. If the retaining screw is to be used as your earth ground, verify that it is at ground by measuring the resistance between it and a cold-water pipe with an ohmmeter. The reading should be zero ohms. If a cold-water pipe is not accessible, connect a 60- to 100-watt trouble-light (not a neon lamp) between the hot side of the receptacle and the retaining screw. Try both slots, if necessary, to locate the hot side on the line; the lamp should light at normal brilliance if the screw is at ground potential (see Figure B).

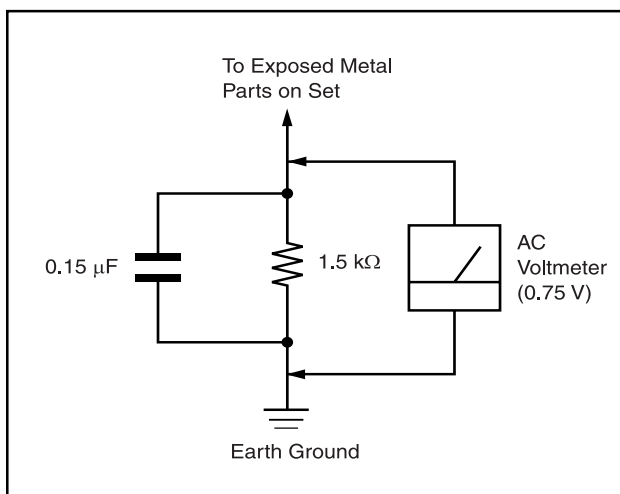

Figure A. Using an AC voltmeter to check AC leakage.

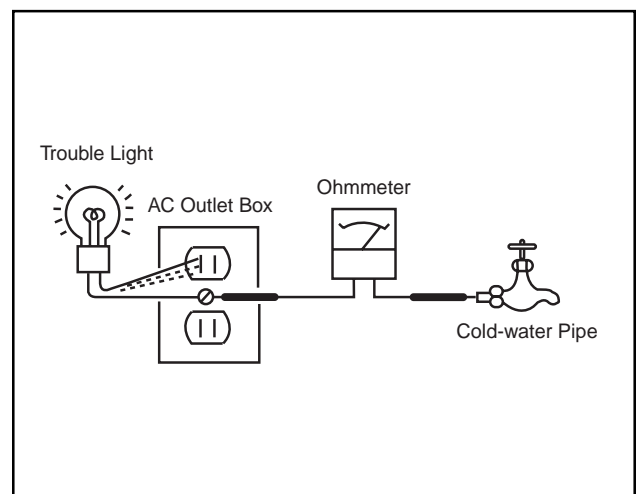

Figure B. Checking for earth ground.

The instructions mentioned here are partial abstracts from the Operating Instruction Manual. The page numbers shown reflect those of the Operating Instruction Manual.

## Connecting Your TV

Read this section before setting up your TV for the first time. This section covers basic connections in addition to any optional equipment you may be connecting.

### Basic Connections

#### TV with indoor or outdoor antenna, or CATV cable

Depending on the cable available in your home, choose one of the connections below:

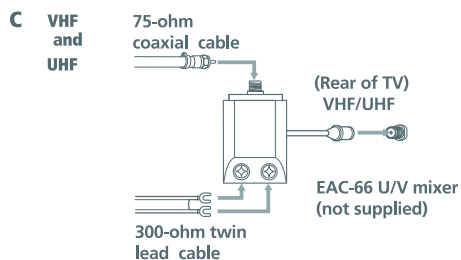
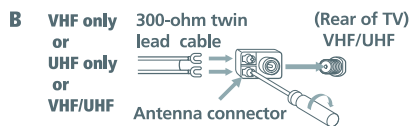
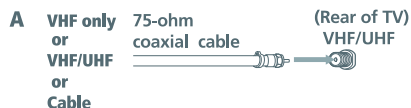

If you are connecting to an indoor or outdoor antenna, you may need to adjust the orientation of the antenna for best reception.

## Connecting Additional Equipment

### TV and VCR

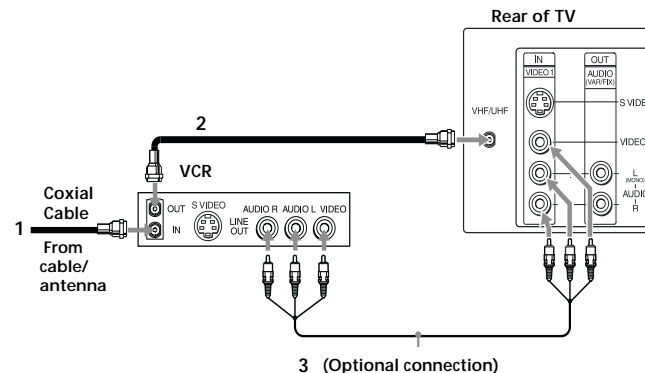

- 1 Connect the coaxial cable from your TV antenna or cable service to the IN jack on your VCR.
- 2 Connect a coaxial cable (not supplied) from the OUT jack on your VCR to the VHF/UHF jack on the TV.

To watch video programs from your VCR, tune your TV to channel 3 or 4 (as set on the rear of your VCR).

#### (Optional connection)

- 3 If your VCR is equipped with video outputs, you can get better picture quality by connecting A/V cables (not supplied) from AUDIO and VIDEO OUT on your VCR to AUDIO/VIDEO IN on your TV.

You can use the TV/VIDEO button to switch between the VHF/UHF and VIDEO inputs.

For optimum picture quality, use S VIDEO (if your VCR is equipped with the S VIDEO connection) instead of the yellow A/V cable. S VIDEO does not provide sound, the audio cables must still be connected.

## TV and Cable Box

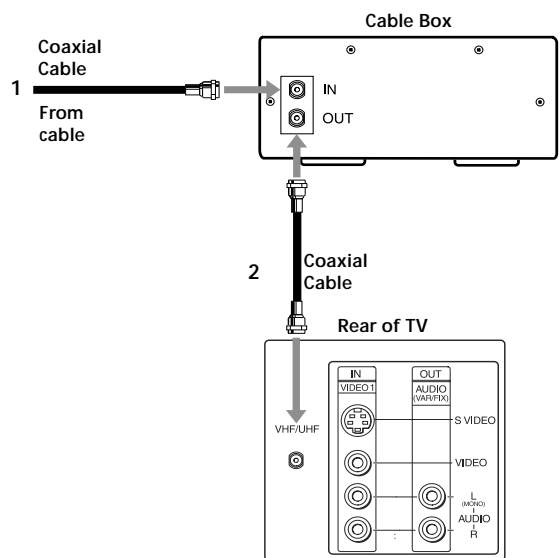

- 1** Connect the coaxial cable from your cable service to the IN jack on your cable box.
- 2** Connect a coaxial cable (not supplied) from the OUT jack on your cable box to the VHF/UHF jack on the TV.

To view channels from your cable box, tune your TV to channel 3 or 4 (as set on the rear panel of your cable box) and use the cable box's remote control to change channels.

If you will be controlling all channel selection through your cable box, you should consider using the Channel Fix feature, (see page 21).

## TV, VCR and Cable box

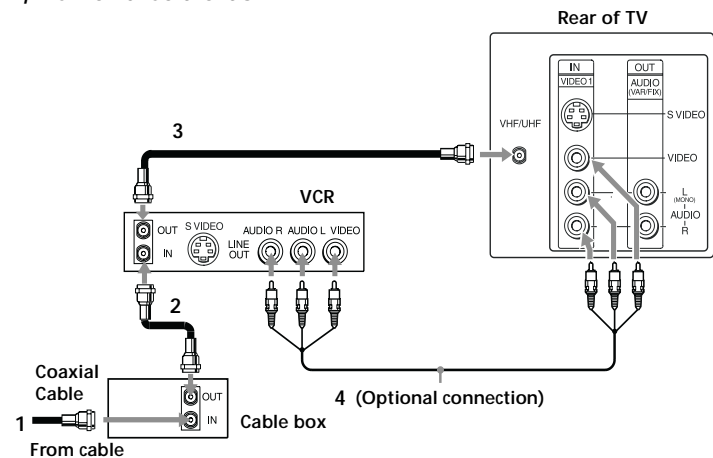

- 1** Connect the coaxial cable from your cable service to the IN jack on your cable box.
- 2** Connect a coaxial cable (not supplied) from the OUT jack on your cable box to the IN jack on your VCR.
- 3** Connect a coaxial cable (not supplied) from the OUT jack on your VCR to the VHF/UHF jack on the TV.

If you will be controlling all channel selection through your cable box, you should consider using the Channel Fix feature, (see page 21).

### (Optional connection)

- 4** If your VCR is equipped with video outputs, you can get better picture quality by connecting A/V cables (not supplied) from AUDIO and VIDEO OUT on your VCR to AUDIO/VIDEO IN on your TV.



You can use the button to switch between the VHF/UHF and VIDEO inputs.

For optimum picture quality, use S VIDEO (if your VCR is equipped with the S VIDEO connection) instead of the yellow A/V cable. S VIDEO does not provide sound, the audio cables must still be connected.

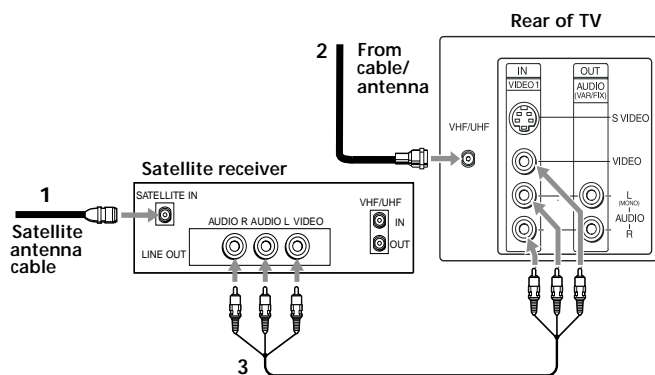
## TV and Satellite Receiver



- 1 Connect the cable from your satellite antenna to SATELLITE IN on your satellite receiver.
- 2 Connect the coaxial cable from your cable service or antenna to the VHF/UHF jack on your TV.
- 3 Using A/V cables, connect AUDIO and VIDEO OUT on your satellite receiver to AUDIO and VIDEO IN on your TV.



 You can use the  button to switch between the VHF/UHF and VIDEO inputs.

 For optimum picture quality, use S VIDEO (if your Satellite Receiver is equipped with the S VIDEO connection) instead of the yellow A/V cable. S VIDEO does not provide sound, the audio cables must still be connected.

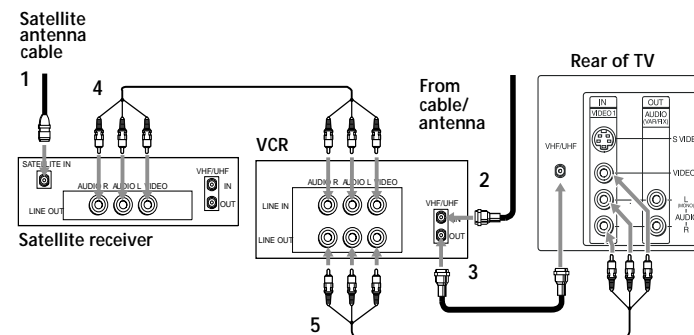
## TV, Satellite Receiver and VCR



- 1 Connect the cable from your satellite antenna to SATELLITE IN on the satellite receiver.
- 2 Connect the coaxial cable from your cable service or antenna to the IN jack on your VCR.
- 3 Using a coaxial cable, connect the OUT jack on your VCR IN to the VHF/UHF jack on your TV.
- 4 Using A/V cables, connect AUDIO and VIDEO OUT on your satellite receiver to AUDIO and VIDEO IN on your VCR.
- 5 Using A/V cables, connect AUDIO and VIDEO OUT on your VCR to AUDIO and VIDEO IN on your TV.

 To view from the satellite receiver or VCR, select the video input to which your satellite receiver or VCR is connected by pressing  on the remote control.

# Using the Remote Control and Basic Functions

This section shows you how to use the more advanced buttons on the remote control and how to use the on-screen menus.

## Using the Remote Control

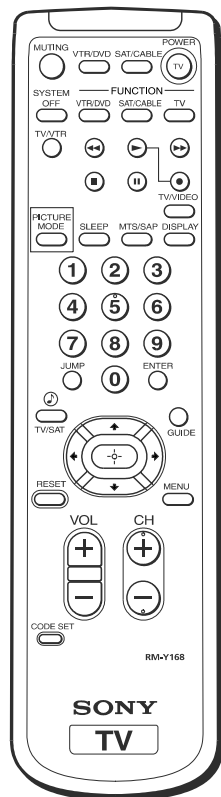

Button	Description
<b>POWER</b>	Press when you want to turn connected equipment on and off.
<b>FUNCTION</b>	Press when you want to control connected equipment with your remote control.
<b>MUTING</b>	Instantly turns off the sound. Press again or press  to restore sound.
<b>SYSTEM OFF</b>	Powers off all Sony equipment at once, (may not work with older equipment).
<b>TV/VIDEO</b>	Cycles through available video inputs.
<b>TV/VTR</b>	Press when you are finished using a VCR and you want to switch to the TV input. Your VCR power will remain on.
	Moves the cursor in the on-screen menus. Press the arrow buttons to move the cursor, press the center button to select or access an option.
<b>PICTURE MODE</b>	Cycles through the available Video Mode settings.
<b>SLEEP</b>	Turns the TV off automatically in approximately 15, 30, 45, 60, or 90 minutes. Cancel by pressing until SLEEP OFF appears.

<b>MTS/SAP</b>	Cycles through the Multi-channel TV Sound (MTS) options: Stereo, Mono, and Auto-SAP (Second Audio Programming).
<b>DISPLAY</b>	Press to display the current time, (if set) and channel number.
<b>JUMP</b>	Cycles through available Steady Sound settings, (see page 19). Alternates between the last two channels selected with the  buttons.
<b>GUIDE</b>	Brings up the custom guide of your satellite receiver.
<b>MENU</b>	Displays the on-screen menu. Press again to exit the menu at any time.
<b>RESET</b>	Press to return to factory settings while in an on-screen menu.
<b>CODE SET</b>	Use to program your remote control to operate connected video equipment, (see page 31).

If you lost your remote control, see page 35.

(continued)

## Troubleshooting

If you are having a problem with your TV, try the suggestions below. If the problem persists, contact your nearest Sony dealer.

<b>No picture, no sound</b>	<ul style="list-style-type: none"> <li><input type="checkbox"/> Make sure the power cord is plugged in.</li> <li><input type="checkbox"/> If a red light is flashing on the front of your TV for more than a few minutes, disconnect and reconnect the power cord to restore the TV. If the problem continues, call your local service center.</li> <li><input type="checkbox"/> Check the TV/VIDEO settings: when watching TV, set to TV; when watching video equipment, set to VIDEO (page 11).</li> <li><input type="checkbox"/> Make sure the batteries have been inserted correctly into the remote control (page 2).</li> <li><input type="checkbox"/> Try another channel, it could be station trouble.</li> </ul>
<b>Poor or no picture, good sound</b>	<ul style="list-style-type: none"> <li><input type="checkbox"/> Adjust Picture in the Video menu (page 18).</li> <li><input type="checkbox"/> Adjust Brightness in the Video menu (page 18).</li> <li><input type="checkbox"/> Check the antenna and/or cable connections (page 3).</li> </ul>
<b>Good picture, no sound</b>	<ul style="list-style-type: none"> <li><input type="checkbox"/> Press  so that MUTING disappears from the screen (page 11).</li> <li><input type="checkbox"/> Check your Audio settings. Your TV may be set to Auto-SAP (page 20).</li> </ul>
<b>No color</b>	<ul style="list-style-type: none"> <li><input type="checkbox"/> Adjust Color in the Video menu (page 18).</li> </ul>
<b>Only snow appears on the screen</b>	<ul style="list-style-type: none"> <li><input type="checkbox"/> Check the Cable setting in the Options menu under Setup (page 30).</li> <li><input type="checkbox"/> Check the antenna and/or cable connections (page 3).</li> <li><input type="checkbox"/> Make sure the channel selected is currently broadcasting.</li> </ul>
<b>Dotted lines or stripes</b>	<ul style="list-style-type: none"> <li><input type="checkbox"/> Adjust the antenna.</li> <li><input type="checkbox"/> Move the TV away from other electronic equipment. Some electronic equipment can create electrical noise, which can interfere with TV reception.</li> </ul>
<b>Double images or ghosts</b>	<ul style="list-style-type: none"> <li><input type="checkbox"/> Check your outdoor antenna or call your cable service.</li> </ul>

### Cannot receive higher number channels (UHF) when using an antenna

Make sure Cable is set to OFF in the Options menu under Setup (page 30).

Perform Auto Program to add channels that are not presently in the memory (page 13).

### Cable stations don't seem to work

Make sure Cable is set to ON in the Options menu under Setup (page 30).

Perform Auto Program to add channels that are not presently in the memory (page 13).

### Remote control does not operate

Batteries could be weak. Replace them (page 2).

Move the TV 3-4 or more feet away from fluorescent lights.









### The TV needs to be cleaned

Clean the TV with a soft dry cloth. Never use strong solvents such as thinner or benzine, which might damage the finish of the cabinet.

### Lost password for Parental Control

In the password screen, enter the following master password: 4357. After using the master password, you must create a new password, it cannot be used to unlock currently blocked channels.

### You lost your remote control

You can use the front A/V panel controls to access the menu. Press  to open the menu. Use the  and  buttons on the front A/V panel instead of the  and  buttons on the remote control. Use the  button on the front A/V panel instead of the  and  buttons on the remote control. Press  again when the setting or adjustment is complete. Contact your nearest Sony dealer to order a replacement. Should you require further assistance, please call the Sony Technical Support number for your country. One of Sony's Technical Support professionals will be happy to assist you.

*If, after reading these Operating Instructions, you have additional question related to the use of your Sony television, please call our Direct Response Center at 1-800-222-SONY (7669) (U.S. resident only) or (416) 499-SONY (7669) (Canadian resident only).*

## SECTION 2 DISASSEMBLY

### 2-1. REAR COVER REMOVAL

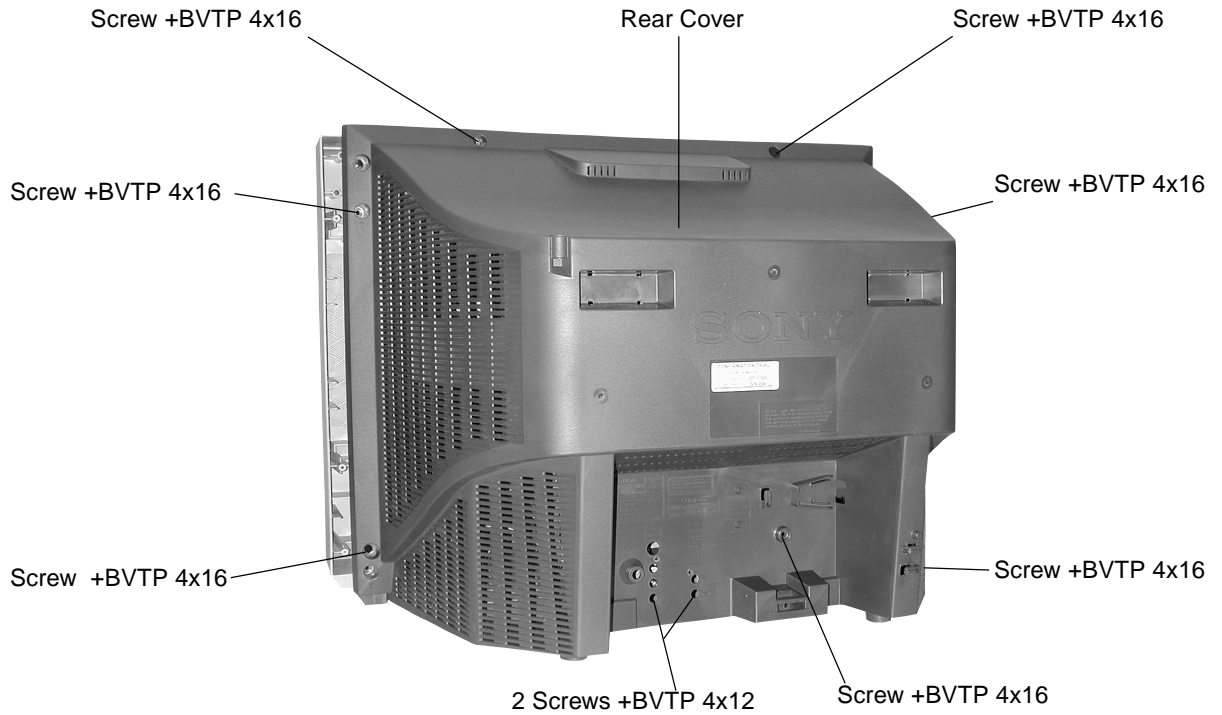

### 2-2. CHASSIS ASSEMBLY REMOVAL

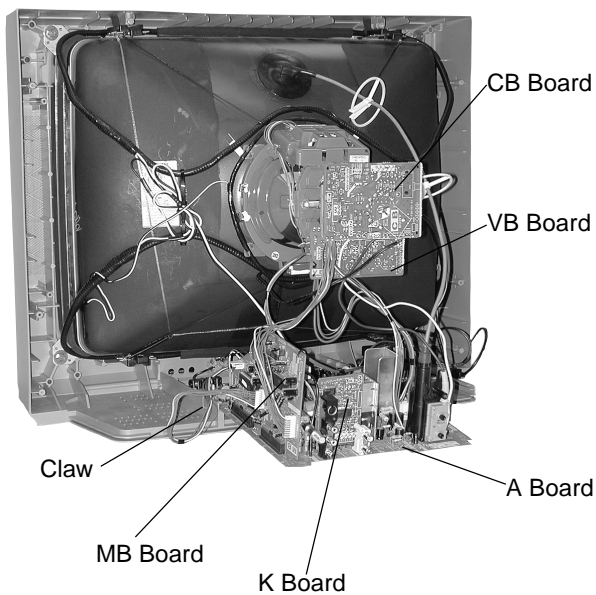

### 2-3. SERVICE POSITION

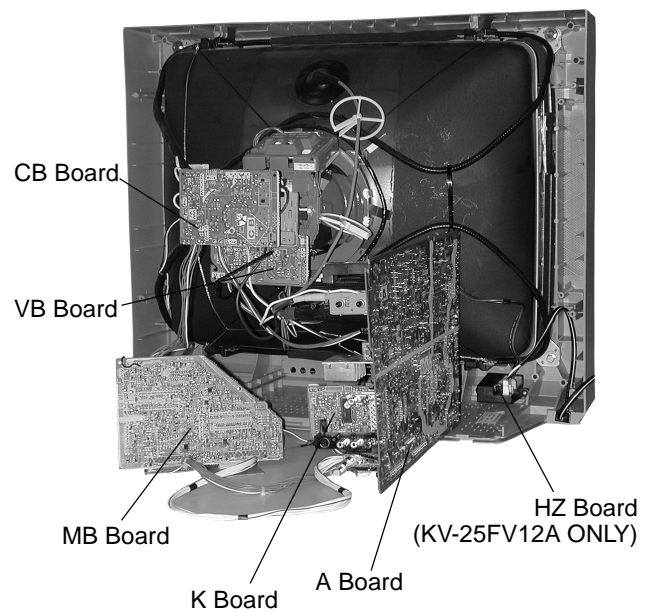

## 2-4. PICTURE TUBE REMOVAL

**WARNING:  
BEFORE REMOVING  
THE ANODE CAP**

High voltage remains in the CRT even after the power is disconnected. To avoid electric shock, discharge CRT *before* attempting to remove the anode cap. Short between anode and CRT coated earth ground strap.

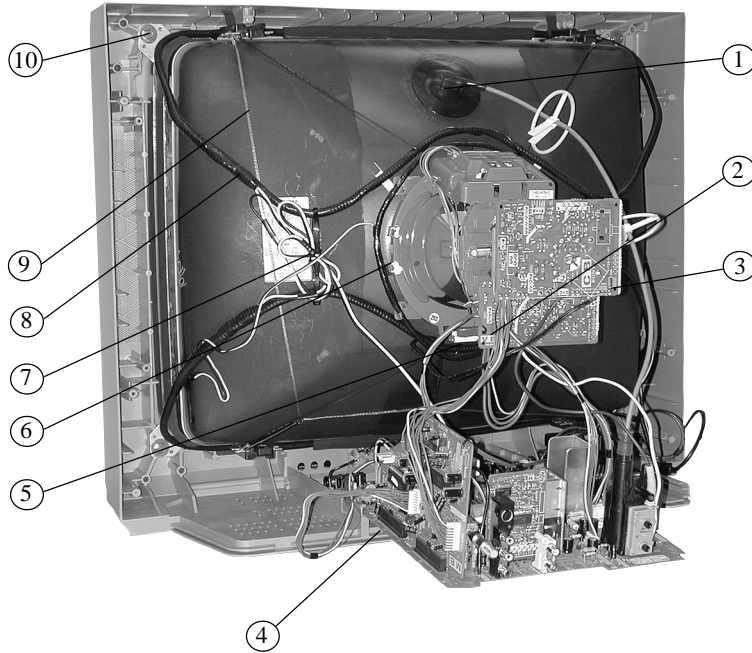
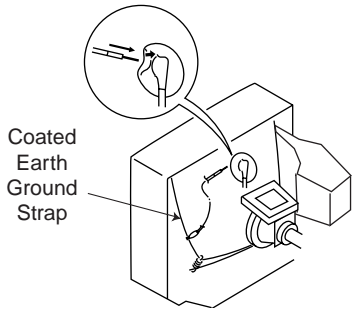

1. Discharge the anode of the CRT and remove the anode cap.
2. Unplug all interconnecting leads from the deflection yoke, neck assembly, degaussing coils and CRT grounding strap.
3. Remove the CB Board from the CRT.
4. Remove the chassis assembly.
5. Loosen the neck assembly fixing screw and remove.
6. Loosen the deflection yoke fixing screw and remove.
7. Place the set with the CRT face down on a cushion and remove the degaussing coil holders.
8. Remove the degaussing coils.
9. Remove the CRT grounding strap and spring tensioners.
10. Unscrew the four CRT fixing screws [located on each CRT corner] and remove the CRT [Take care not to handle the CRT by the neck].

### ANODE CAP REMOVAL

**WARNING:** High voltage remains in the CRT even after the power is disconnected. To avoid electrical shock, discharge the CRT *before* attempting to remove the anode cap. Short between anode and coated earth ground strap of CRT.

**NOTE:** After removing the anode, short circuit the anode of the picture tube and the anode cap to either the metal chassis, CRT shield, or carbon painted on the CRT.

### REMOVAL PROCEDURES

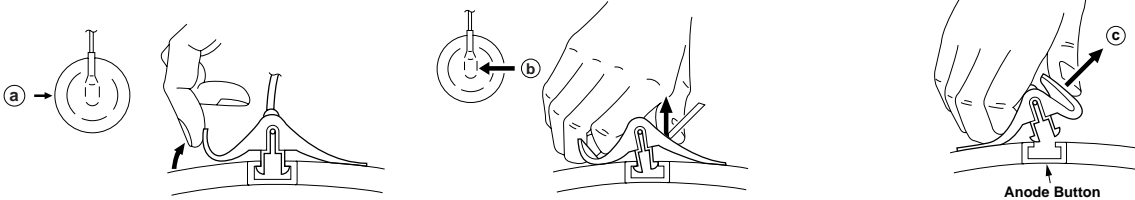

- ① Turn up one side of the rubber cap in the direction indicated by arrow **a**.
- ② Use your thumb to pull the rubber cap firmly in the direction indicated by arrow **b**.
- ③ When one side of the rubber cap separates from the anode button, the anode cap can be removed by turning the rubber cap and pulling it in the direction of arrow **c**.

### HOW TO HANDLE AN ANODE CAP

- ① Do not use sharp objects which may cause damage to the surface of the anode cap.
- ② To avoid damaging the anode cap, do not squeeze the rubber covering too hard. A material fitting called a shatter-hook terminal is built into the rubber.
- ③ Do not force turn the foot of the rubber cover. This may cause the shatter-hook terminal to protrude and damage the rubber.

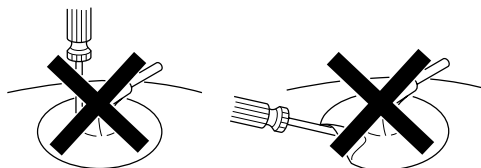

## SECTION 3 SET-UP ADJUSTMENTS

The following adjustments should be made when a complete realignment is required or when a new picture tube is installed.

These adjustments should be performed with rated power supply voltage unless otherwise noted.

Set the controls as follows unless otherwise noted:

VIDEO MODE: STANDARD

PICTURE control: ..... Normal

BRIGHTNESS control: ..... Normal

Perform the adjustments in order as follows:

1. Beam Landing
2. Convergence
3. Focus
4. Screen (G2)
5. White Balance

**Note:** Test equipment required:

- Color Bar Pattern Generator
- Degausser
- DC Power Supply
- Digital Multimeter

### 3-1. BEAM LANDING

Before beginning adjustment procedure:

1. Degauss the entire screen.
2. Feed in the white pattern signal.

#### Adjustment Procedure

1. Input a raster signal with the pattern generator.
2. Loosen the deflection yoke mounting screw and set the purity control to the center as shown below.

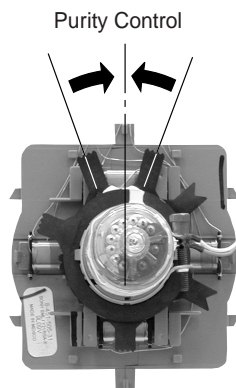

3. Turn the raster signal of the pattern generator to green.
4. Move the deflection yoke backward and adjust the purity control so that green is in the center and red and blue are at the sides evenly.

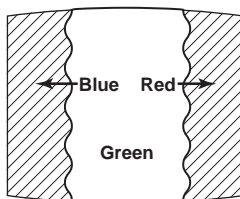

5. Move the deflection yoke forward and adjust so that the entire screen becomes green.

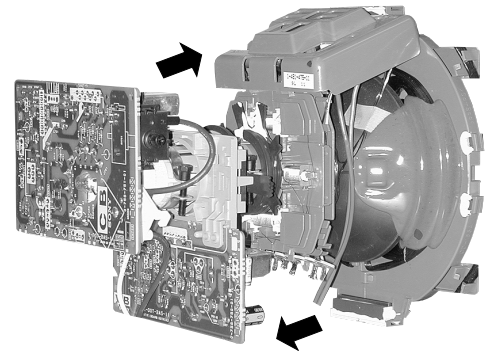

6. Switch over the raster signal to red and blue and confirm the condition.
7. When the position of the deflection yoke is determined, tighten it with the deflection yoke mounting screw.
8. If landing at the corner is not right, adjust by using the disk magnets.

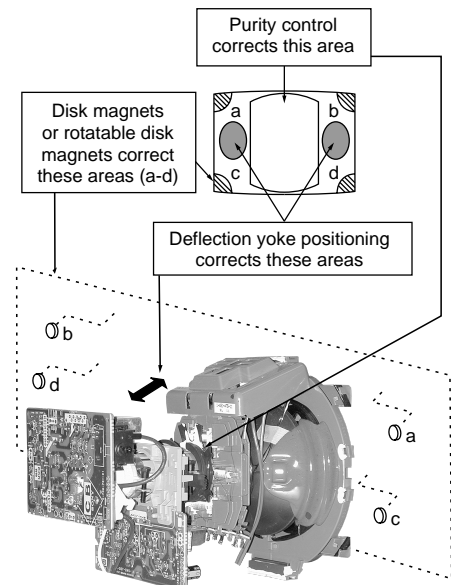

### 3-2. CONVERGENCE

Before starting convergence adjustments:

1. Perform FOCUS, V.LIN AND V.SIZE adjustments.
2. Set BRIGHTNESS control to minimum.
3. Feed in dot pattern.

#### Vertical Static Convergence

1. Adjust V.STAT magnet to converge red, green and blue dots in the center of the screen (Vertical movement adjust V.STAT RV701 to converge).

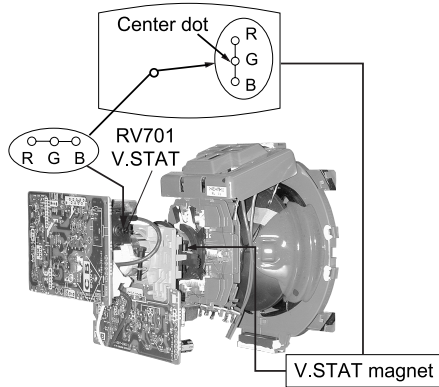

2. Tilt the V.STAT magnet and adjust static convergence to open or close the V.STAT magnet.

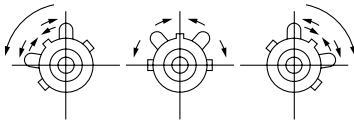

When the V.STAT magnet is moved in the direction of arrows a and b, red, green, and blue dots move as shown below:

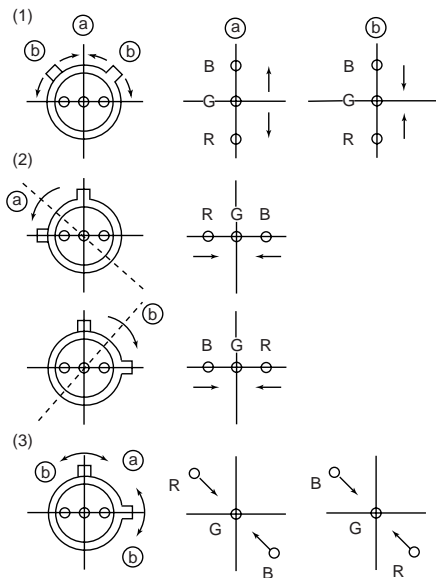

#### Horizontal Static Convergence

If the blue dot does not converge with the red and green dots, perform the following:

1. Move BMC magnet (a) to correct insufficient H. Static convergence.
2. Rotate BMC magnet (b) to correct insufficient V. Static convergence.
3. After adjusting the BMC magnet, repeat Beam Landing Adjustment.

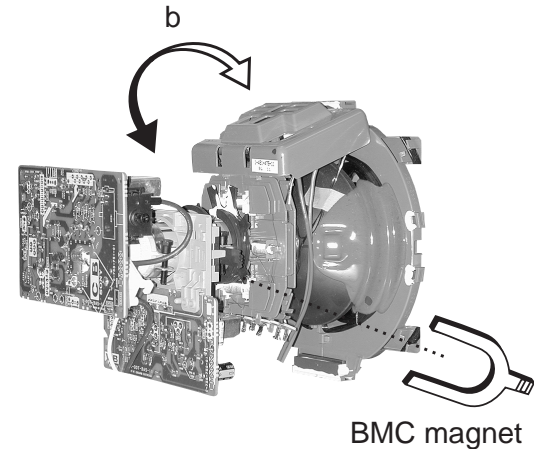
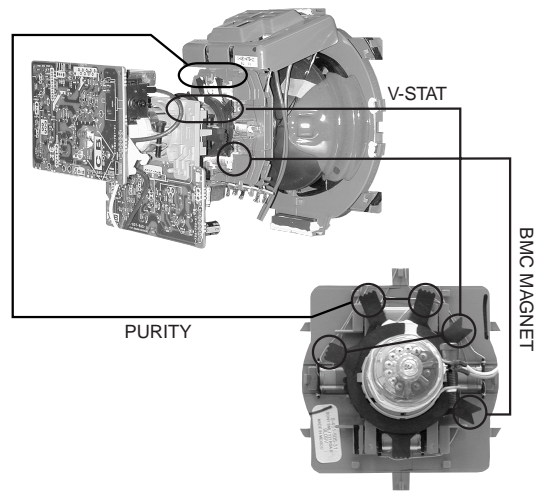

#### Dynamic Convergence Adjustment

Before performing this adjustment, perform Horizontal and Vertical Static Convergence Adjustment.

1. Slightly loosen deflection yoke screw.
2. Remove deflection yoke spacers.
3. Move the deflection yoke for best convergence as shown on the following page.

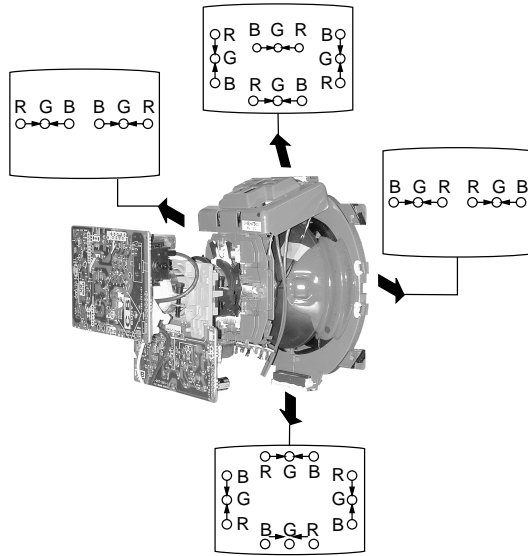

4. Tighten the deflection yoke screw.
5. Install the deflection yoke spacers.

### TLH Plate Adjustment

1. Input crosshatch pattern.
2. Adjust PICTURE QUALITY to standard, PICTURE and BRIGHTNESS to 50%, and OTHER to standard.
3. Adjust the Horizontal Convergence of red and blue dots by tilting the TLH plate on the deflection yoke.

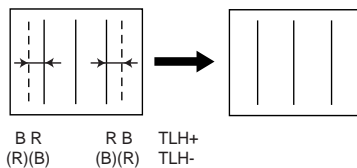
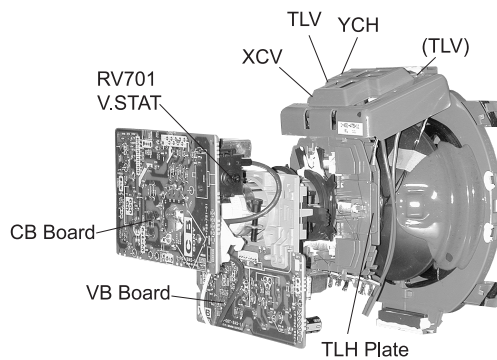

4. Adjust XCV core to balance X axis.
5. Adjust YCH VR to balance Y axis.
6. Adjust vertical red and blue convergence with V.TILT (TLV VR).

Perform adjustments while tracking items 1 and 2.

### Screen-Corner Convergence

1. Affix a permalloy assembly corresponding to the misconverged areas.

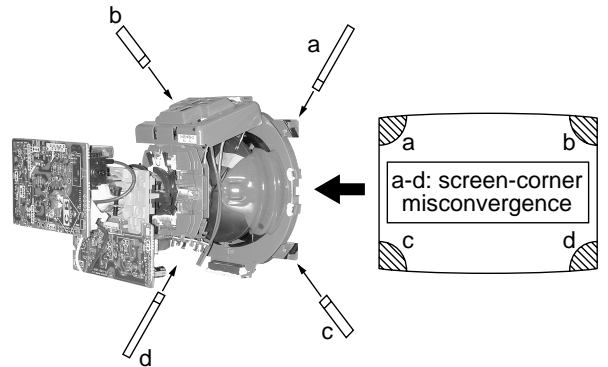

### 3-3. FOCUS

1. Adjust FOCUS control for best picture.

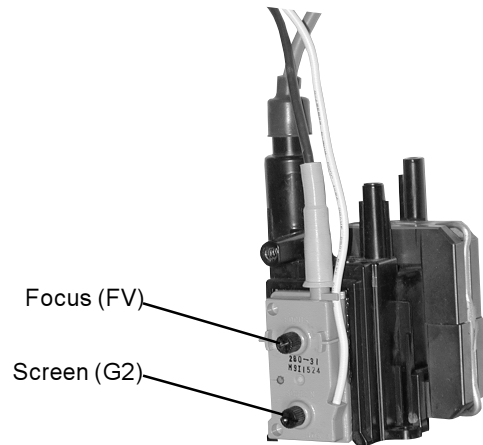

### 3-4. SCREEN (G2)

1. Input a dots pattern.
2. Set the PICTURE and BRIGHTNESS controls at minimum and COLOR control at normal.
3. Adjust SBRT, GCUT, BCUT in service mode with an oscilloscope as shown below so that voltages on the red, green, and blue cathodes are 170 VDC.

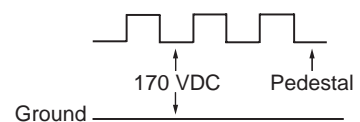

4. Observe the screen and adjust SCREEN (G2) VR in FBT to obtain the faintly visible background of dot signal.

### 3-5. METHOD OF SETTING THE SERVICE ADJUSTMENT MODE

#### Service Mode Procedure

- Standby mode (power off).
- [Display] → Channel [5] → Sound volume [+] → Power on the Remote Commander (press each button within a second).

#### Service Adjustment Mode In

- The CRT displays the item being adjusted.

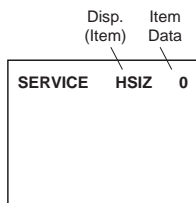

- Press [1] or [4] on the Remote Commander to select the item.
- Press [3] or [6] on the Remote Commander to change the data.
- Press [MUTING] then [ENTER] to save into the memory.

#### Service Adjustment Mode Memory

Turn set off then on to exit service adjustment mode.

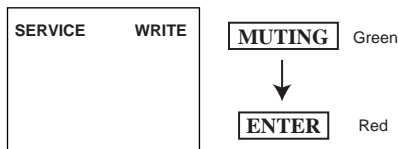

### 3-6. WHITE BALANCE ADJUSTMENTS

- Input an entire white signal with burst.
- Set to Service Adjustment Mode.
- Set DCOL to "0".
- Set the PICTURE and BRIGHTNESS to minimum.
- Adjust with SBRT if necessary.
- Select GCUT and BCUT with [1] and [4].
- Adjust with [3] and [6] for the best white balance.
- Set PICTURE and BRIGHTNESS to maximum.
- Select GDRV and BDRV with [1] and [4].
- Adjust with [3] and [6] for the best white balance.
- Reset DCOL to "1".
- To write into memory, press [MUTING] then [ENTER].

## SECTION 4 SAFETY RELATED ADJUSTMENTS

### 4-1. R564 CONFIRMATION METHOD (HV HOLD-DOWN CONFIRMATION) AND READJUSTMENTS

The following adjustments should always be performed when replacing the following components which are marked with  on the schematic diagram:

Part Replaced ( <input checked="" type="checkbox"/> )	Adjustment ( <input checked="" type="checkbox"/> )
DY, T505, CRT, IC501, C507, C520, C505, C509, C515, T504, T503, C551, L510, C546, C537, C547, D517, D518, D519, R560, R561, R562, R563, R565, R566, R567, R525 ..... A Board	HV HOLD-DOWN R564
IC1301 ..... MB Board	

#### Preparation Before Confirmation

- Using a Variac, apply AC input voltage:  $120-220 \pm 2$  VAC.
- Turn the POWER switch ON.
- Input a white signal and set the PICTURE and BRIGHTNESS controls to maximum.
- Confirm that the voltage between C546 (+) or TP503 and ground is more than 97 VDC.

#### Hold-Down Operation Confirmation

- Connect the current meter between Pin 11 of the FBT (T505) and the PWB land where Pin 11 would normally attach. (See Figure 1 on the next page.)
- Input a dot signal and set PICTURE and BRIGHTNESS to minimum:  $IABL = 100 \pm 100 \mu A$ .
- Confirm the voltage of A Board TP-600 is  $135 \pm 1$  VDC.
- Connect the digital voltmeter and the DC power supply via diode 1SS119 to C546 (+) and ground. (See Figure 1 on the next page.)
- Increase the DC power voltage gradually until the picture blanks out.
- Turn DC power source off immediately.
- Read the digital voltmeter indication (standard  $< 138 \pm 0.3$  VDC).
- Input a white signal and set PICTURE and BRIGHTNESS to maximum:  $IABL = 1650 \pm 100 \mu A$ .
- Repeat steps 4 to 7.

#### Hold-Down Readjustment

If the setting indicated in step 2 of Hold-Down Operation Confirmation cannot be met, readjustment should be performed by altering the resistance value of R564 component marked with .

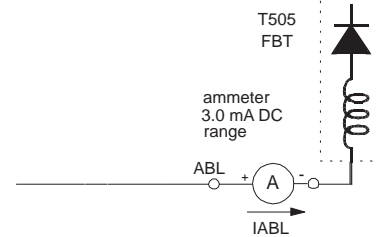

### 4-2. B+ VOLTAGE CONFIRMATION AND ADJUSTMENT

Note: The following adjustments should always be performed when replacing the following components, which are marked with  on the schematic diagram on the A Board.

<b>A BOARD:</b> IC601, PH601
------------------------------

- Using a Variac, apply AC input voltage:  $130 \pm 2$  VAC.
- Input a dot signal.
- Set the PICTURE and BRIGHTNESS controls to minimum.
- Confirm that the voltage of A Board TP-600 is  $< 136$  VDC.
- If step 4 is not satisfied, replace the components listed above, then repeat steps 1–3.

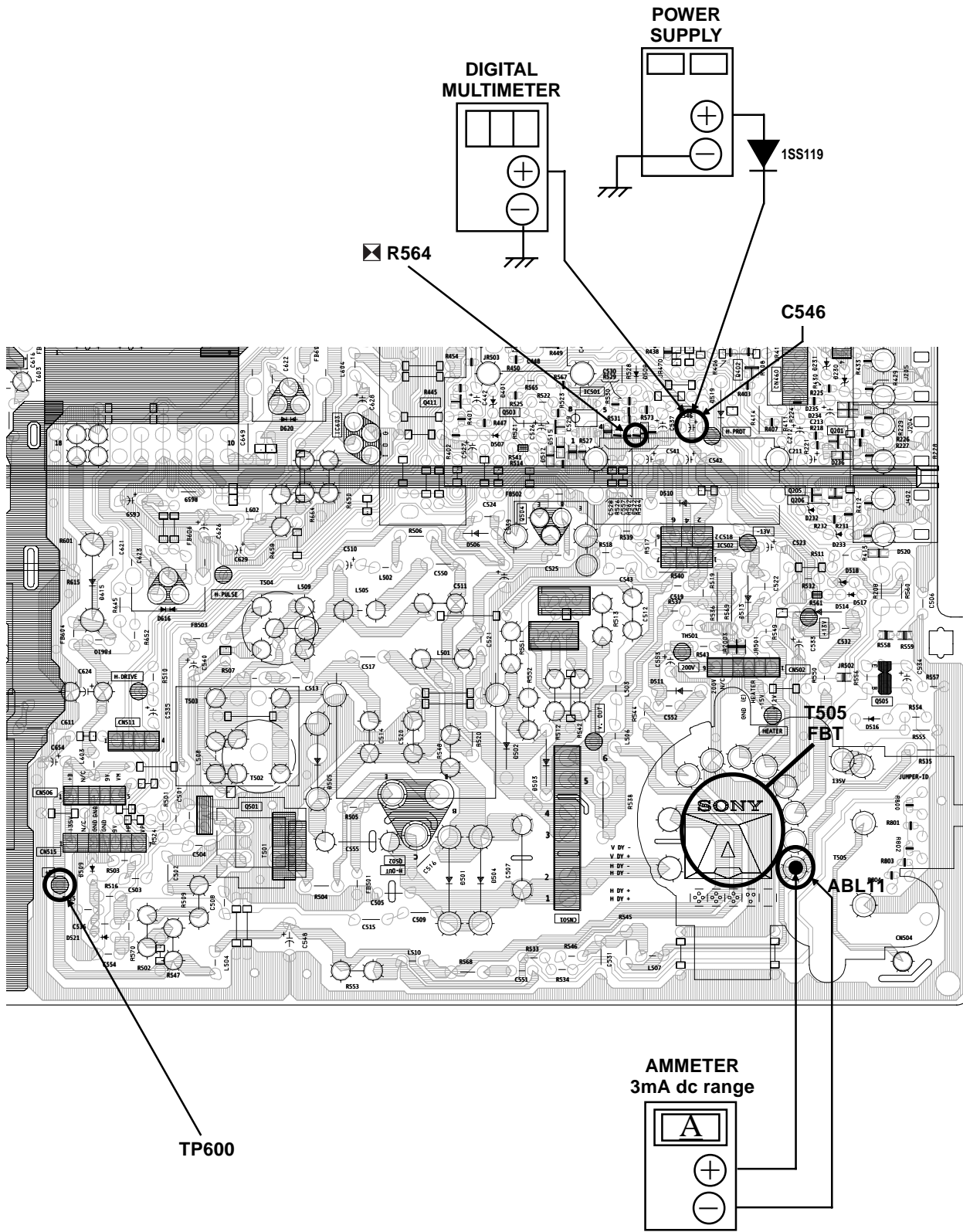

Figure 1

## SECTION 5 CIRCUIT ADJUSTMENTS

### ELECTRICAL ADJUSTMENTS BY REMOTE COMMANDER

Use the Remote Commander (RM-Y168) to perform the circuit adjustments in this section.

NOTE: Test Equipment Required:

- Pattern generator
- Frequency counter
- Digital multimeter
- Audio oscillator

#### 5-1. SETTING THE SERVICE ADJUSTMENT MODE

1. Standby mode (power off).
2. **Display** → Channel **5** → Sound volume **+** → Power on the Remote Commander (press each button within a second).

#### Service Adjustment Mode On

1. The CRT displays the item being adjusted.

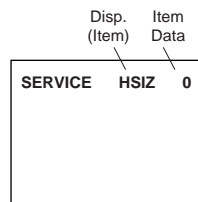

2. Press **1** or **4** on the Remote Commander to select an item.
3. Press **3** or **6** on the Remote Commander to change the data.
4. Press **MUTING** then **ENTER** to save into the memory.

#### Service Adjustment Mode Memory

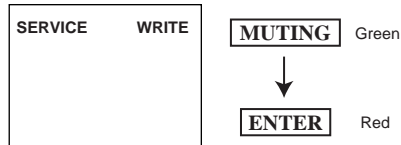

1. Press **8** then **ENTER** on the Remote Commander to initialize.

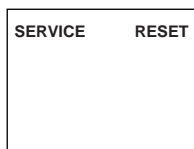

Carry out step 1 when adjusting IDs 0–4 and when replacing and adjusting IC1003.

2. Turn set off then on to exit service adjustment mode.

#### 5-2. MEMORY WRITE CONFIRMATION METHOD

1. After adjustment, remove the power plug from the AC outlet, then plug it in again.
2. Turn the power switch ON and set to service mode.
3. Call the adjusted items again to confirm they were adjusted.

#### 5-3. ADJUSTMENT BUTTONS AND INDICATORS

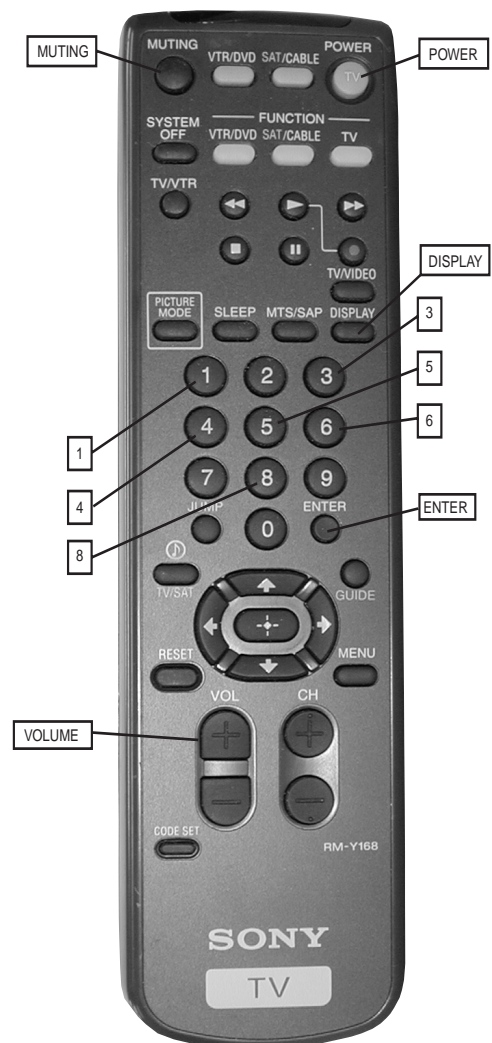

RM-Y168

## Adjustment Items

Reg #	ITEM	FUNCTION	RANGE	FIX DATA	NTSC	PAL M	PAL N	VIDEO	RF	AVERAGE DATA	
1	HSIZ	Horizontal Size Adjustment	0-63		35	35	35			38	
2	HPOS	Horizontal Position Adjustment	0-63		33	33	33			21	
3	VBOW	Vertical Line Bowing Adj.	0-15		5	5	5			9	
4	VANG	Vertical line Bowing Slant Adj.	0-15		7	7	7			5	
5	TRAP	Horizontal Trapezoid Adj.	0-15		7	7	7			7	
6	PAMP	Horizontal PIN Distortion Adj.	0-63		7	7	7			32	
7	UPIN	Upper PIN Distortion Adj.	0-63		36	36	36			39	
8	LPIN	Lower PIN Distortion Adj.	0-63		36	36	36			39	
9	VM	Velocity Modulation On/Off	0,1		Palette mode controls this register						0
10	BLKO	Vertical Blanking On/Off	0,1	0						0	
11	VMLV	Velocity Modulation Level	0-3		Palette mode controls this register						2
12	AGN2	Aging 2	0,1	0						0	
13	REFP	Reference Pulse Position	0,1	0						0	
14	VBLK	Vertical Blanking On/Off	0,1	0						0	
15	JPSW		0,1	0						0	
16	VSIZ	Vertical Size Adjustment	0-63		40	47	47			49	
17	VPOS	Vertical Position Adj.	0-63		32	32	32			32	
18	VLIN	Vertical Linearity Adj.	0-15		7	7	7			6	
19	SCOR	Vertical "S" Correction Adjustment	0-15		6	6	6			8	
20	VZOM	16:9 CRT Z Mode On/Off	0,1	0						0	
21	EHT	Vertical High-Voltage Correction	0-15	6						6	
22	ASP	Aspect Ratio Control	0-63	47						47	
23	SCRL	16:9 CRT Z Mode Trans. Scroll	0-63	31						31	
24	HBLK	Horizontal Blanking On/Off	0,1	1						1	
25	LBLK	Left Blanking Adjustment	0-15	11						12	
26	RBLK	Right Blanking Adjustment	0-15	8						5	
27	VUSN	V Saw Waveform Compress	0,1	0						0	
28	HDW	Horizontal Drive Pulse Width	0,1	1						1	
29	EWDC	"Parabola" EW/ D.C. Adjustment	0,1	0						0	
30	LVLN	Lower Screen BTM Vertical Line Adj.	0-15	0						0	
31	UVLN	Upper Screen BTM Vertical Line Adj.	0-15	0						0	
32	HTRAP	Horizontal Trapezoid Adj.	0,1	****						0	
33	RDRV	R Output Drive Control	0-63	31						36	
34	GDRV	G Output Drive Control	0-63	21						26	
35	BDRV	B Output Drive Control	0-63	21						25	
36	RCUT	R Output Cutoff Control	0-15	10						8	
37	GCUT	G Output Cutoff Control	0-15	6						6	
38	BCUT	B Output Cutoff Control	0-15	6						7	
39	DCOL	Dynamic Color On/Off	0,1	0						1	
40	SHUE	Sub HUE	0-31	15						15	
41	SCOL	Sub Color	0-31		15	15	15			15	
42	SBRT	Sub BRIGHTNESS	0-31	16						15	
43	RON	R Output On/Off	0,1	1						1	
44	GON	G Output On/Off	0,1	1						1	
45	BON	B Output On/Off	0,1	1						1	
46	AXPL	Axis PAL	0,1	0						0	
47	AXNT	Axis NTSC	0,1	1						0	
48	CBPF	Chroma BPF On/Off	0,1	1						1	
49	CTRP	Y TRAP FILTER On/Off	0,1	1						1	
50	COFF	Color On/Off	0,1	0						0	
51	KOFF	Set Color Killer	0,1	0						0	
52	SSHP	Sub SHARPNESS	0-15	5						7	
53	SHPF	SHARPNESS Circuit Fo	0,1		Palette mode controls this register						1
54	PREL	Pre-Shoot / Over-Shoot	0,1	1						1	
55	Y-DC	DC Transmission Ratio Switching	0,1		Palette mode controls this register						1
56	GAMM	Gamma Correction Amnt	0-3		Palette mode controls this register						1
57	ABLM	ABL Mode Switching	0,1	1						1	
58	VTH	ABL CD VHT Switching	0,1	1						1	
59	YDEL	Y Delay Time Control	0-15	7						7	
60	NCOL	No Color ID	0,1	1						1	
61	FSC	FSC Out On/Off	0,1	1						1	
62	K-ID	Killer ID Control On/Off	0,1	0						0	
63	HOOSC	Horizontal VCO Oscillation Freq.	0-15	7						7	

Reg #	ITEM	FUNCTION	RANGE	FIX DATA	NTSC	PAL M	PAL N	VIDEO	RF	AVERAGE DATA	
64	VSS	Vertical Sync Slice Level	0,1	**						0	
65	HSS	Horizontal Sync Slice Level	0,1	0						0	
66	HMSK		0,1	0						0	
67	VTMS	Select Signal VTIM Pin	0-3	0						0	
68	CDMD	Vertical Count Down Mode Switching	0-3					3	***	0	
69	AFC	AFC Loop Gain Switching	0-3		0			0	0	0	
70	FIFR	Field Frequency	0-3	*	3	1	1			3	
71	SBAL	Sub Balance	0-15	5						7	
72	SBAS	Sub Bass	0-15	0						9	
73	STRE	Sub Treble	0-15	3						9	
74	BBEL	BBE Low	0-15	4						12	
75	BBEH	BBE High	0-15	5						9	
76	SRND	Surround	0,63	0						13	
77	BBE	BBE On/Off	0,1	0						1	
78	DISP	O.S.D Display Position	0-63	15						15	
79	TROT	Tilt Correction	0-63	31						31	
80	HCLW	Horizontal Count Lower Limit	0-127	16						16	
81	HCHG	Horizontal Count High Limit	0-127	64						64	
82	ABL0		0,1	4						1	
83	ABL1		0-7		Palette mode controls this register						7
84	SYSC	Color System	0-7	0						6	
85	VENH	Vertical Enhancement	0-7	0						4	
86	CBPC		0,1	3						0	
87	BYCF		0,1	0						0	
88	KILC		0,1		Palette mode controls this register						0
89	LDOT		0,1	1						0	
90	CORE		0,1	1						0	
91	CHTR		0,1	0							
92	CHPF		0,1	1							
93	ENHO		0,1	0							
94	ID0		0,255	25						See ID Map	
95	ID1		0,255	3						See ID Map	
96	ID2		0,255	91						See ID Map	
97	ID3		0,255	2						See ID Map	
98	ID4		0,255	233						See ID Map	
99	ID5		0,255	17						See ID Map	
100	ID6		0,255	0						See ID Map	

\* FIFR = 3 for NTSC models, FIFR=1 for Trinorma models

\*\* VSS = 1 for US & CND, VSS=0 for Other

\*\*\* CDMD = 3 for US & CND, CDMD =0 for Other

\*\*\*\* KV-25FV12A/25FV12C =1; Others = 0

SERVICE	ID0	25
---------	-----	----

#### Notes:

No. 1–100 show the order that each adjustment mode may be selected while in service mode.

Data Range shows the range of possible settings for each adjustment mode.

Initial Data shows the standard settings for each adjustment mode.

### Feature ID Map

	Destination	ID-0	ID-1	ID-2	ID-3	ID-4	ID-5	ID-6
KV-24FV12	(US)	89	19	239	50	137	19	0
KV-24FV12	(CND)	89	19	239	50	137	19	0
KV25FV12	(E)	17	19	255	2	233	19	0
KV25FV12C	(E)	17	19	255	2	233	19	0
KV25FV12A	(E)	23	19	255	2	233	19	128

## 5-4. MB BOARD ADJUSTMENTS

### H. Frequency (Free Run) Check

1. Input a TV mode (RF) with no signal.
2. Connect a frequency counter to base of Q501 (TP-500 H. DRIVE) on the A Board.
3. Check H. Frequency for  $15735 \pm 200$  Hz, and  $15650 \pm 200$  Hz for PAL-N (KV-25FV12A ONLY.)

### V. Frequency (Free Run) Check

1. Select video 1 with no signal input.
2. Set the conditions for a standard setting.
3. Connect the frequency counter to TP-502 (V OUT) or CN501 pin ⑥ (V DY+) and ground on the A Board.
4. Check that V. Frequency shows  $60 \pm 4$  Hz for NTSC,  $50 \pm 4$  Hz for PAL-N (KV-25FV12A ONLY).

### Drive (RDRV)

1. Input a color-bar signal and set the level to 75%.
2. In Standard mode, set PICTURE to maximum and COLOR to minimum.
3. Activate the Service Adjustment Mode.

- Set both GON and BON items. Using [3] and [6]; set each to the following values. Leave RON set to "1".

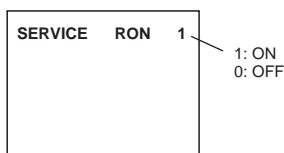

R ON: ON (1)  
 G ON: OFF (0)  
 B ON: OFF (0)

- Select the DCOL item and set it to "0".
- Connect an oscilloscope probe to CB Board, J701 pin ⑫ (KR) (RED OUT).
- Select RDRV with [1] and [4].
- Adjust the value of RDRV with [3] and [6] for  $92.0 \pm 2$  VDC.

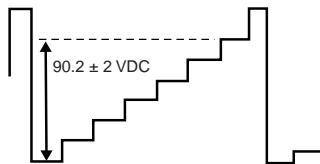

- Reset the item DCOL to "1".
  - Reset GON and BON values to "1".
- R ON: ON (1)  
 G ON: ON (1)  
 B ON: ON (1)
- Reset Picture and Color to normal values:
- PICTURE: MAX  
 COLOR: CENTER
- Press [MUTING] then [ENTER] to save into the memory.

### Display Position Adjustment (DISP)

- Input a color-bar signal.
- Set to Service Adjustment Mode.
- Select DISP with [1] and [4].
- Adjust values of DISP with [3] and [6] to adjust characters to the center.
- Write to memory by pressing [MUTING] then [ENTER].
- Check to see if the text is displayed on the screen.

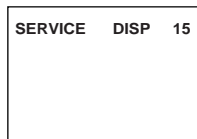

### Sub Bright Adjustment (SBRT)

- Input a monoscope signal.
- Activate the Service Adjustment Mode.
- Set the PICTURE and BRIGHTNESS to minimum.
- Select the SBRT item with [1] and [4].

- Adjust the values of SBRT with [3] and [6] to obtain a faintly visible crosshatch.
- Press [MUTING] then [ENTER] to save into the memory.

### Sub Hue, Sub Color Adjustment (SHUE, SCOL)

- Input a color-bar signal and set level to 75%.
- Activate the Service Adjustment Mode.
- Select the DCOL item and set the value to "0".
- Connect an oscilloscope probe to CB Board, CN705 Pin ④ (Blue Out).
- Select the SHUE and SCOL item with [1] and [4].
- While showing the SHUE item, adjust the waveform with [3] and [6] until the second and third bars show the same level ( $V2 = V3 < 0.1$  Vp-p).
- While showing the SCOL item, adjust the waveform with [3] and [6] until the first and fourth bars show the same level ( $V1 = V4 < 0.1$  Vp-p).
- Input RF PAL-M and PAL-N color-bar and repeat steps 1-7 for each. (KV-25FV12A ONLY).

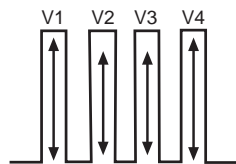

- Select the DCOL item and reset to 1.
- Press [MUTING] then [ENTER] to save into the memory.

### V. Size Adjustment (VSIZ)

- Input a crosshatch signal.
- Activate the Service Adjustment Mode.
- Select the VSIZ item with [1] and [4].
- Adjust value of VPOS with [3] and [6] for the best vertical center.
- Press [MUTING] then [ENTER] to save into the memory.

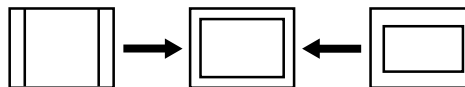

### V. Center Adjustment (VPOS)

Perform this adjustment after performing H. Frequency (Free Run) Check.

- Input a crosshatch signal.
- Activate the Service Adjustment Mode.
- Select the VPOS item with [1] and [4].
- Adjust value of VPOS with [3] and [6] for the best vertical center.
- Press [MUTING] then [ENTER] to save into the memory.

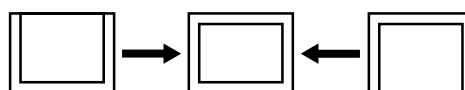

## H. Center Adjustment (HPOS)

Perform this adjustment after performing H. Frequency (Free Run) Check.

1. Input a crosshatch signal.
2. Activate the Service Adjustment Mode.
3. Select the HPOS item with **[1]** and **[4]**.
4. Adjust the value of HPOS with **[3]** and **[6]** for the best horizontal center.5. Press **[MUTING]** then **[ENTER]** to save into the memory.

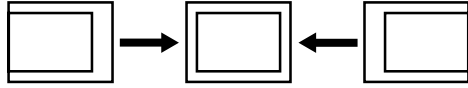

## H. Size Adjustment (HSIZ)

1. Input a monoscope signal.
2. Activate the Service Adjustment Mode.
3. Select HSIZ with **[1]** and **[4]**.
4. Adjust with **[3]** and **[6]** for the best horizontal size.
5. Press **[MUTING]** then **[ENTER]** to save into the memory.

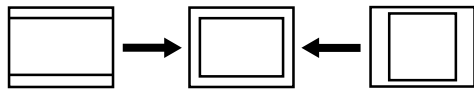

## V. Linearity (VLIN), V. Correction (VSCO), Pin Amp (PAMP), and Horizontal Trapezoid (TRAP) Adjustments

1. Input a crosshatch signal.
2. Activate the Service Adjustment Mode.
3. Select VLIN, VSCO, PAMP, and PPHA with **[1]** and **[4]**.
4. Adjust with **[3]** and **[6]** for the best horizontal size.
5. Press **[MUTING]** then **[ENTER]** to save into the memory.

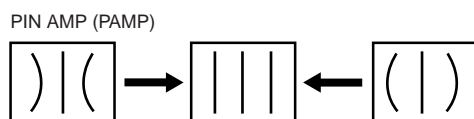
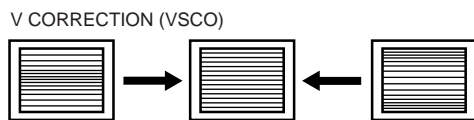
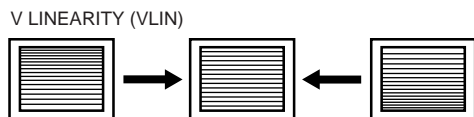

## V. Angle (VANG), V. Bow (VBOW), Upper pin (UPIN) and Low Pin (LPIN) Adjustments

1. Input a crosshatch signal.
2. Activate the Service Adjustment Mode.
3. Select VANG, VBOW, UPIN, and LPIN with **[1]** and **[4]**.
4. Adjust with **[3]** and **[6]** for the best picture.
5. Press **[MUTING]** then **[ENTER]** to save into the memory.

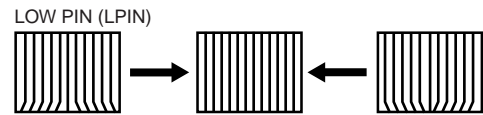
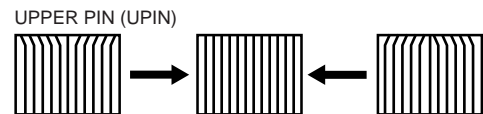
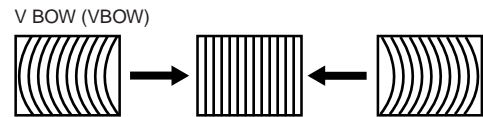
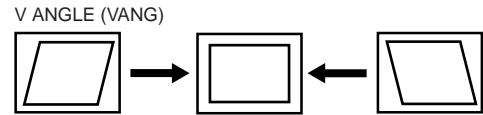

## Service Adjustment Mode Memory

1. Change the value of the DCOL item to "1".
2. After completing all adjustments, press **[0]** then **[ENTER]**.

## Read From Memory

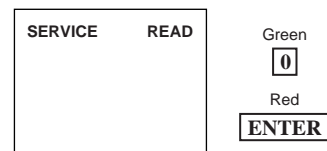



SECTION 6  
DIAGRAMS

6.1 BLOCK DIAGRAM

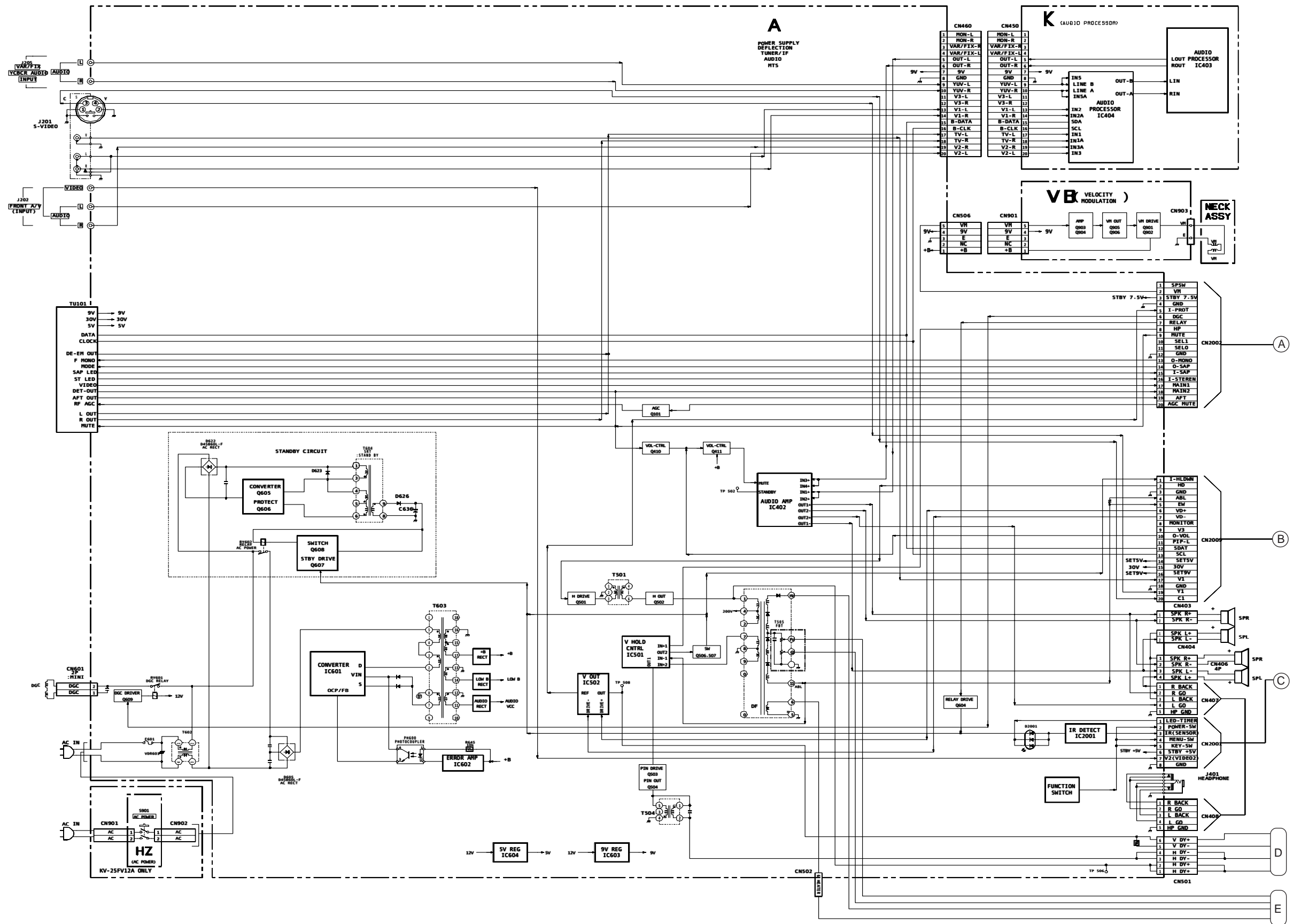

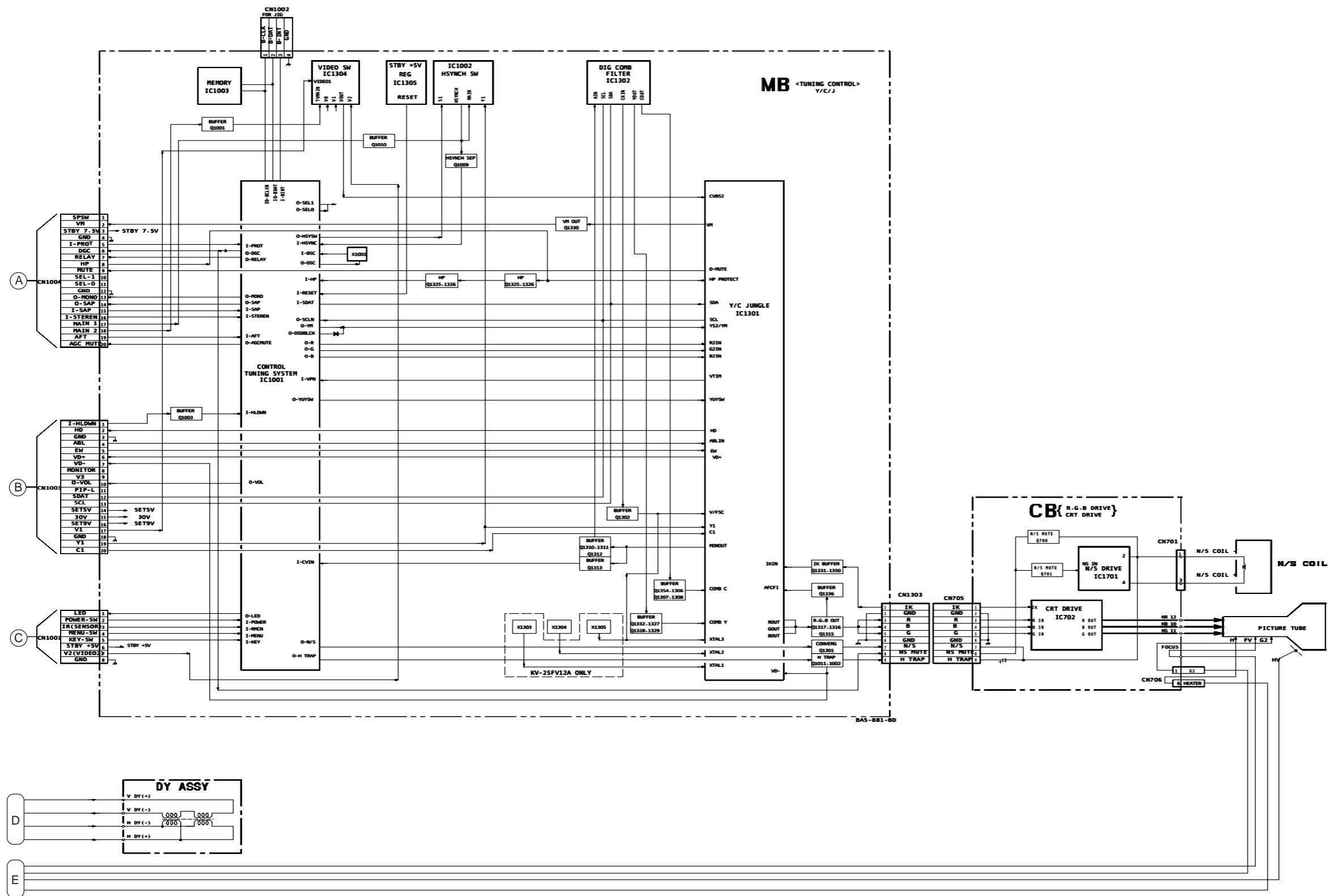

### 6.2 CIRCUIT BOARD LOCATIONS

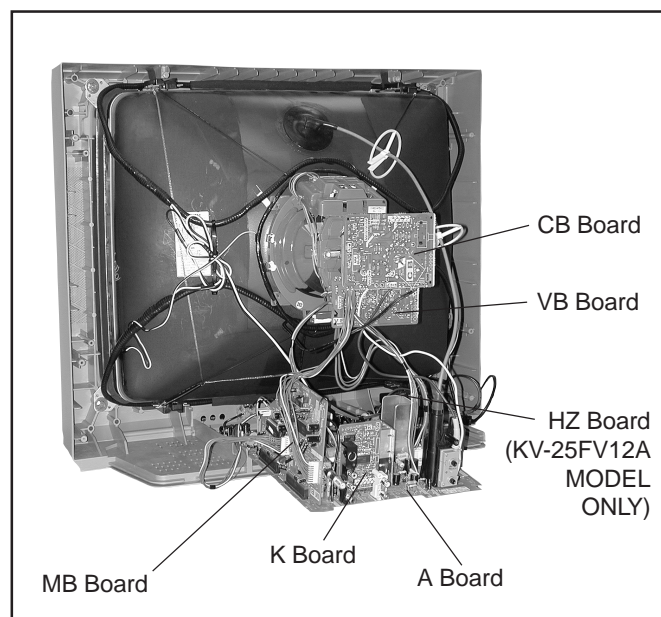

Part Replaced (▣)	Adjustment (⊠)
DY, T505, CRT, IC501, C507, C520, C505, C509, C515, T504, T503, C551, L510, C546, C537, C547, D517, D518, D519, R560, R561, R562, R563, R565, R566, R567, R525.....A Board	HV HOLD-DOWN (R564)
IC1301.....MB Board	
IC601, PH601.....A Board	B+ VOLTAGE CONFIRMATION

- All voltages are in Volts
- Voltage is DC with respect to ground unless otherwise noted.
- Readings are taken with a 10MΩ digital multimeter.
- Readings are taken with a color-bar signal input.
- Voltage variations may be noted due to normal production tolerance.
- Circled numbers are waveform references.
- \* : cannot be measured
- — : B + Line
- - - - : B - Line
- ⇨ : Signal path

#### Reference Information



RESISTOR	: RN	METAL FILM
	: RC	SOLID
	: FPRD	NON FLAMMABLE CARBON
	: FUSE	NON FLAMMABLE FUSIBLE
	: RW	NON FLAMMABLE WIREWOUND
	: RS	NON FLAMMABLE METAL OXIDE
	: RB	NON FLAMMABLE CEMENT
	: *	ADJUSTMENT RESISTOR
COIL	: LF-8L	MICRO INDUCTOR
CAPACITOR	: TA	TANTALUM
	: PS	STYROL
	: PP	POLYPROPYLENE
	: PT	MYLAR
	: MPS	METALIZED POLYESTER
	: MPP	METALIZED POLYPROPYLENE
	: ALB	BIPOLAR
	: ALT	HIGH TEMPERATURE
	: ALR	HIGH RIPPLE

#### Note:

The components identified by shading and ⊠ mark are critical for safety. Replace only with the part number specified. The symbol  (displayed on component side of the circuit board) indicates fast operating fuse. Replace only with fuse of the same rating as marked.

Les composants identifiés per un tramé et une marque ⊠ sont critiques pour la sécurité. Ne les remplacer que par une pièce portant le numéro spécifié. Le symbole  indique une fusible a action rapide. Doit être remplacée par une fusible de même valeur, comme marqué.

### 6-3. PRINTED WIRING BOARDS AND SCHEMATIC DIAGRAMS

- All capacitors are in μF unless otherwise noted. pF: μμF 50 WV or less are not indicated except for electrolytic and tantalums.
- All electrolytics are 50V unless otherwise specified.
- Indication of resistance, which does not have one for rating electrical power, is as follows:  
Pitch: 5mm  
Rating electrical power 1/4W (CHIP: 1/10W)
- All resistors are in ohms.  
KΩ = 1000Ω MΩ = 1000KΩ
-  : nonflammable resistor
-  : fusible resistor
- Δ : internal component
- □ : panel designation and adjustment for repair
- ⊥ : earth-ground
- ⏏ : earth-chassis
- All variable and adjustable resistors have characteristic curve B, unless otherwise noted.
- The components identified by ⊠ in this manual have been carefully factory-selected for each set in order to satisfy regulations regarding X-ray radiation. Should replacement be required, replace only with the value originally used.
- When replacing components identified by ▣, make the necessary adjustments indicated. If results do not meet the specified value, change the component identified by ⊠ and repeat the adjustment until the specified value is achieved (refer to Safety Related Adjustments on page 19).
- When replacing parts shown in the table below, be sure to perform the related adjustments.

### A BOARD IC BLOCK DIAGRAMS

#### A BOARD: IC402 TDA8580Q/N1

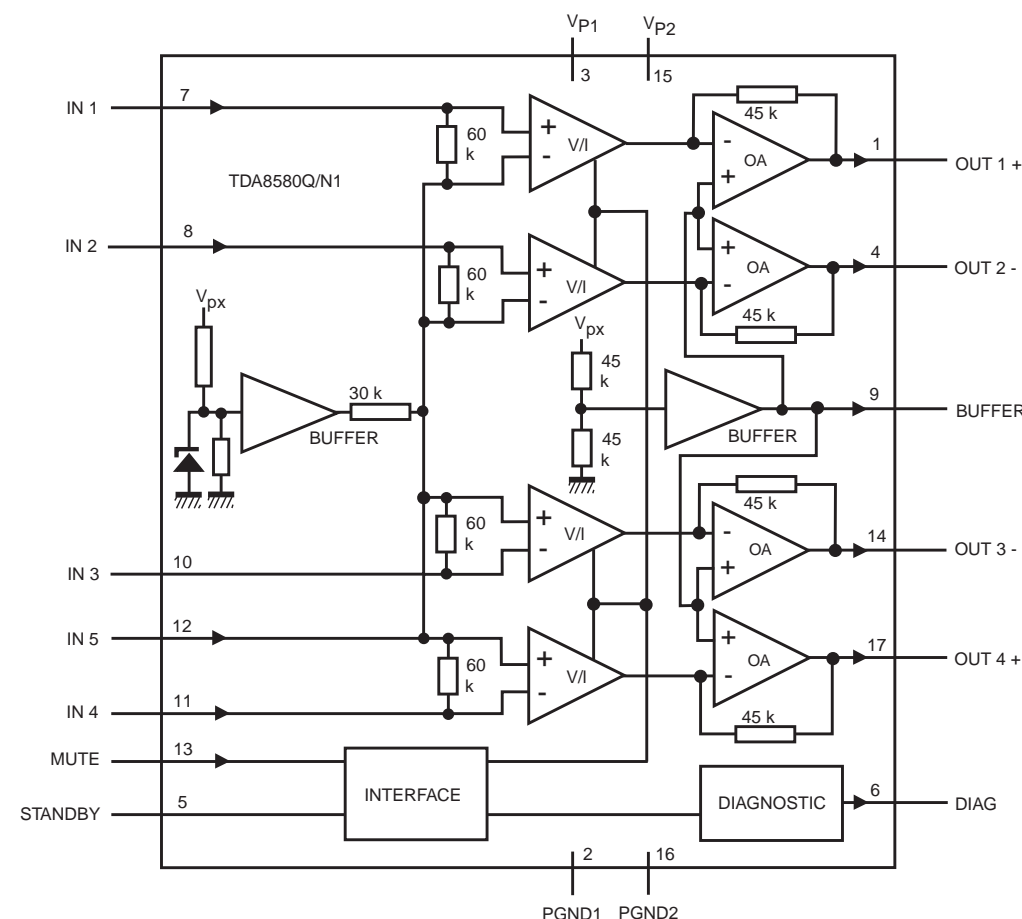

#### A BOARD: IC502 TDA8172

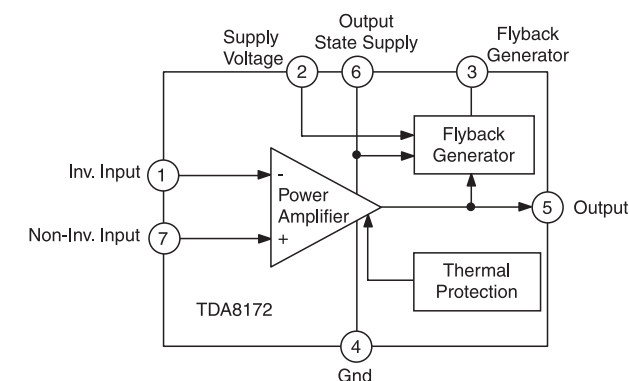

**A**

[POWER SUPPLY, DEFLECTION, TUNER/IF, AUDIO, MTS]

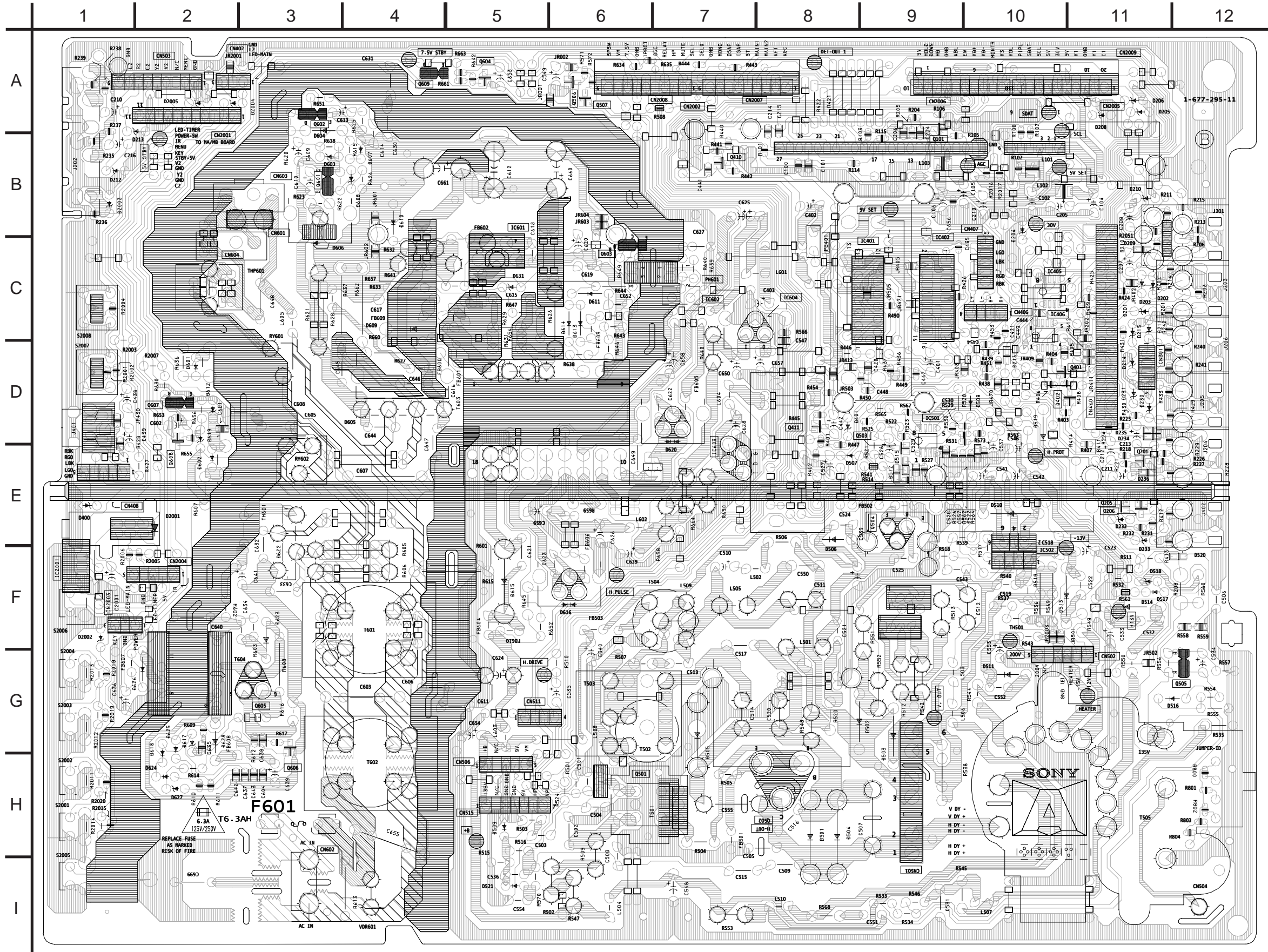

**A BOARD LOCATOR LIST**

DIODE	D617	G-2	
D204	C-10	D618	G-2
D208	B-11	D619	D-2
D209	B-11	D620	E-7
D210	B-11	D622	F-3
D212	B-11	D623	F-3
D213	B-2	D624	H-2
D230	D-11	D625	G-2
D231	D-11	D626	G-2
D400	E-1	D627	H-2
D401	E-8	D628	G-2
D501	H-8	D2001	E-2
D502	G-9	D2002	F-1
D503	G-9	D2003	B-1
D504	H-9	D2004	A-3
D505	G-7	D2005	A-2
D506	E-8	<b>IC</b>	
D507	E-8	IC402	D-9
D508	E-10	IC501	D-9
D509	H-5	IC502	F-10
D510	E-10	IC601	B-5
D511	G-10	IC602	C-7
D513	F-10	IC603	E-7
D514	F-11	IC604	C-8
D516	G-12	IC2001	F-1
D517	F-11	<b>TRANSISTOR</b>	
D518	F-11	Q101	B-9
D519	E-10	Q410	B-7
D520	F-12	Q411	D-8
D601	D-2	Q501	H-6
D602	E-2	Q502	H-7
D603	B-3	Q503	D-8
D604	A-3	Q504	E-9
D605	D-4	Q505	G-11
D606	B-3	Q506	A-6
D607	B-4	Q507	A-6
D609	D-4	Q601	B-3
D608	B-4	Q602	A-3
D610	C-4	Q603	C-6
D611	C-6	Q604	A-5
D612	C-2	Q605	G-3
D613	D-6	Q606	G-3
D614	D-6	Q607	D-2
D615	F-5	Q608	E-2
D616	F-6	Q609	A-4

A BOARD SCHEMATIC DIAGRAM

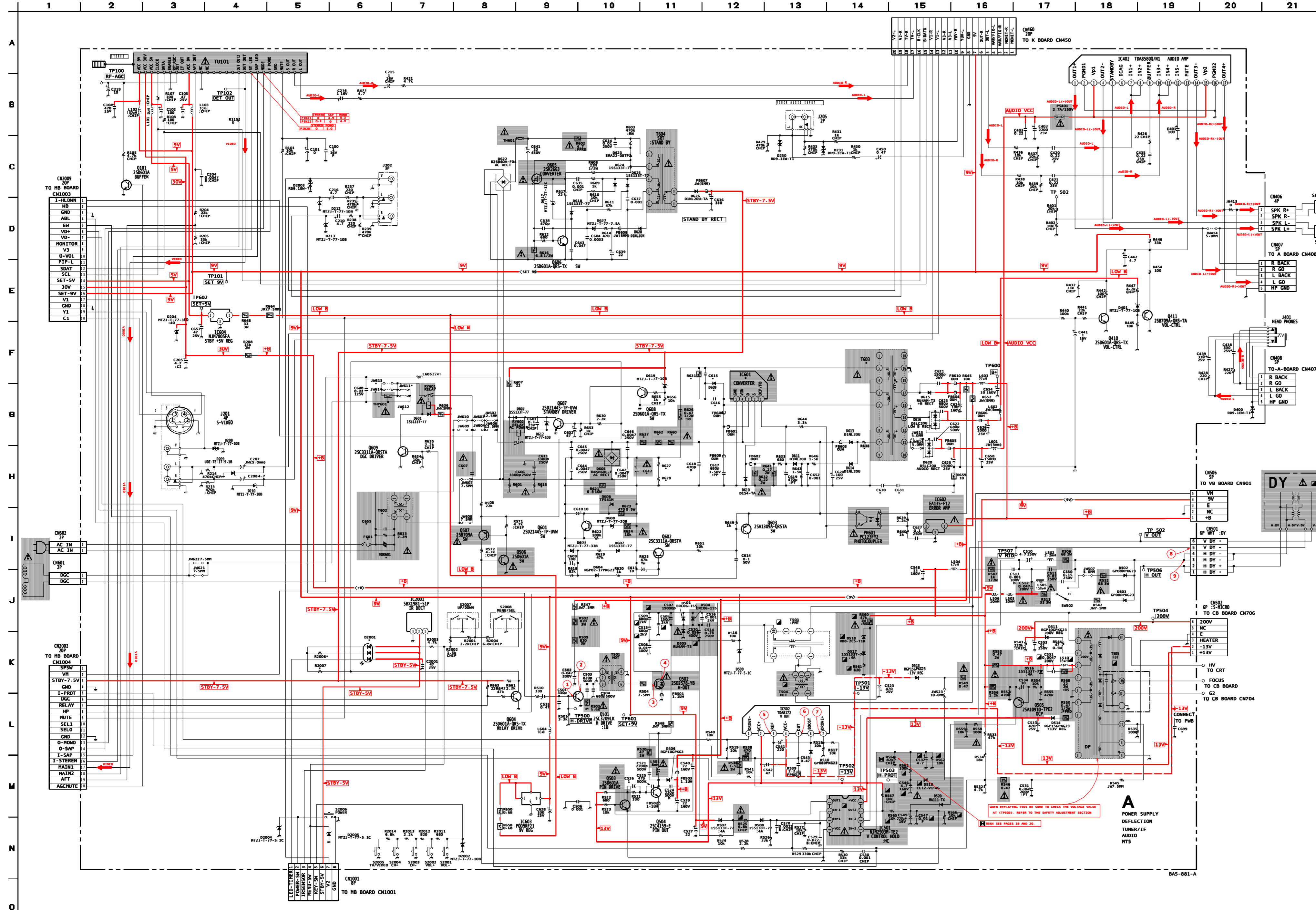

A BOARD MARK (\*) LIST

REF NO.	LOC.	KV-24FV12	KV-25FV12C	KV-25FV12A
C612	H-10	680 UF 250V	560 UF 400V	560 UF 400V
C615	G-12	#	.022 UF 400V	#
C616	G-12	#	220 PF 1KV	220 PF 1KV
C630	H-14	.0047 UF	#	#
C631	H-15	.0047 UF	#	#
D609	G-12	#	RU-1P	RU-1P
D2001	K-6	LNK0120022G1	LNK0120022G1	LNK0220022G1
F601	I-6	6.3A/125V	6.3A/250V	6.3A/250V
IC601	G-12	STR-F6626	STR-F6656	STR-F6656
JW611	G-7	7.5MM	#	#
JW612	G-7	7.5MM	#	#
JW613	F-6	#	5MM	5MM
JW614	F-6	#	5MM	5MM
R601	H-8	4.7M 1/2W	#	#
R615	H-9	#	8.2M 1W	8.2M 1W
R627	H-11	390K	270K	270K
R628	H-11	JW(5MM)	270K	270K
R631	F-11	#	100K 3W	100K 3W
R637	G-10	JW(20MM)	5.6K 3W	5.6K 3W
R638	G-14	33	56	56
R660	G-11	15K 3W	5.6K 3W	5.6K 3W
R662	G-11	JW(20MM)	5.6K 3W	5.6K 3W
R2006	K-5	#	#	0
R2007	K-5	#	#	470
T802	H-7	1-435-617-11	1-426-717-11	1-426-717-11
T803	G-14	1-433-806-11	1-433-807-11	1-433-807-11
THP601	F-6	1-809-539-11	1-803-540-11	1-803-540-11
VDR601	I-6	ENE271D-10A	ENE621D-14A	ENE621D-14A

A BOARD IC VOLTAGE LIST

IC 402	IC501	IC601	IC604
pin	volt	pin	volt
1	6.8	1	0.2
2	GND	2	3.7
3	14.1	3	2.5
4	6.8	4	GND
5	4.3	5	9.5
6	NC	6	10.1
7	4.1	7	0.1
8	4.1	8	14.0
9	6.8	9	123.4
10	4.1	pin	volt
11	4.1	1	2.1
12	4.1	2	14.0
13	5.2	3	-12.6
14	6.8	4	-13.9
15	14.1	5	0.2
16	GND	6	14.3
17	6.8	7	2.1

TU101	14	N/C
pin	volt	15
1	8.6	16
2	30.7	17
3	5.1	18
4	4.9	19
5	4.9	20
6	GND	21
7	5.5	22
8	2.1	23
9	4.9	24
10	4.1	25
11	0.0	26
12	N/C	27
13	N/C	28

A BOARD TRANSISTOR VOLTAGE LIST

Q101	B	C	E	Q506	B	C	E
Q101	0.0	5.6	0.0	Q506	0.0	0.0	0.0
Q410	0.0	5.2	0.0	Q507	0.0	0.0	0.0
Q411	5.3	0.0	5.2	Q604	0.1	4.1	0.0
Q501	0.0	93.3	-0.6	Q606	-36.1	-35.3	-36.3
Q502	-0.1	133	0.0	Q607	0.7	0.1	0.0
Q503	0.2	3.8	0.0	Q608	0.0	0.7	0.0
Q504	0.1	-6.5	0.0	Q609	0.0	13.9	0.0
Q505	134.9	1.8	135.5				

A BOARD TRANSISTOR VOLTAGE LIST

Q605	G	D	S
Q605	40.8	-35.6	36.8

A BOARD WAVEFORMS

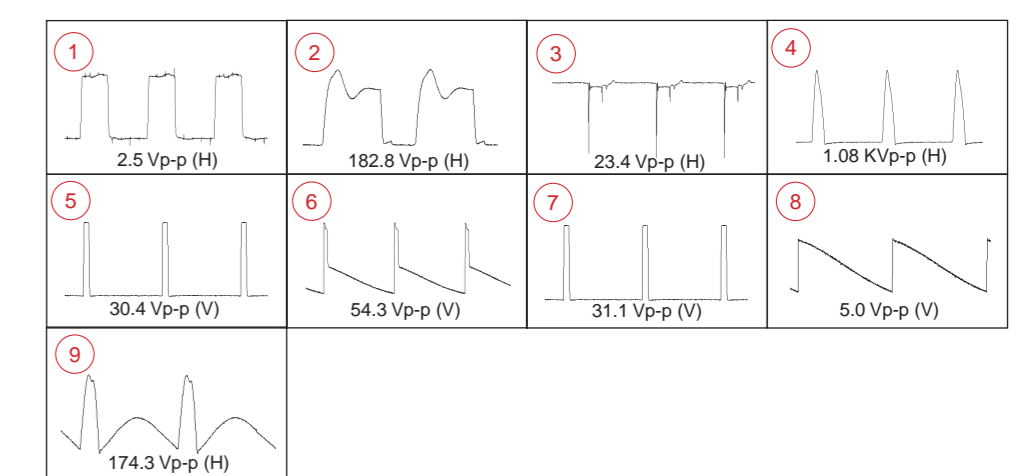

MB BOARD SCHEMATIC DIAGRAM

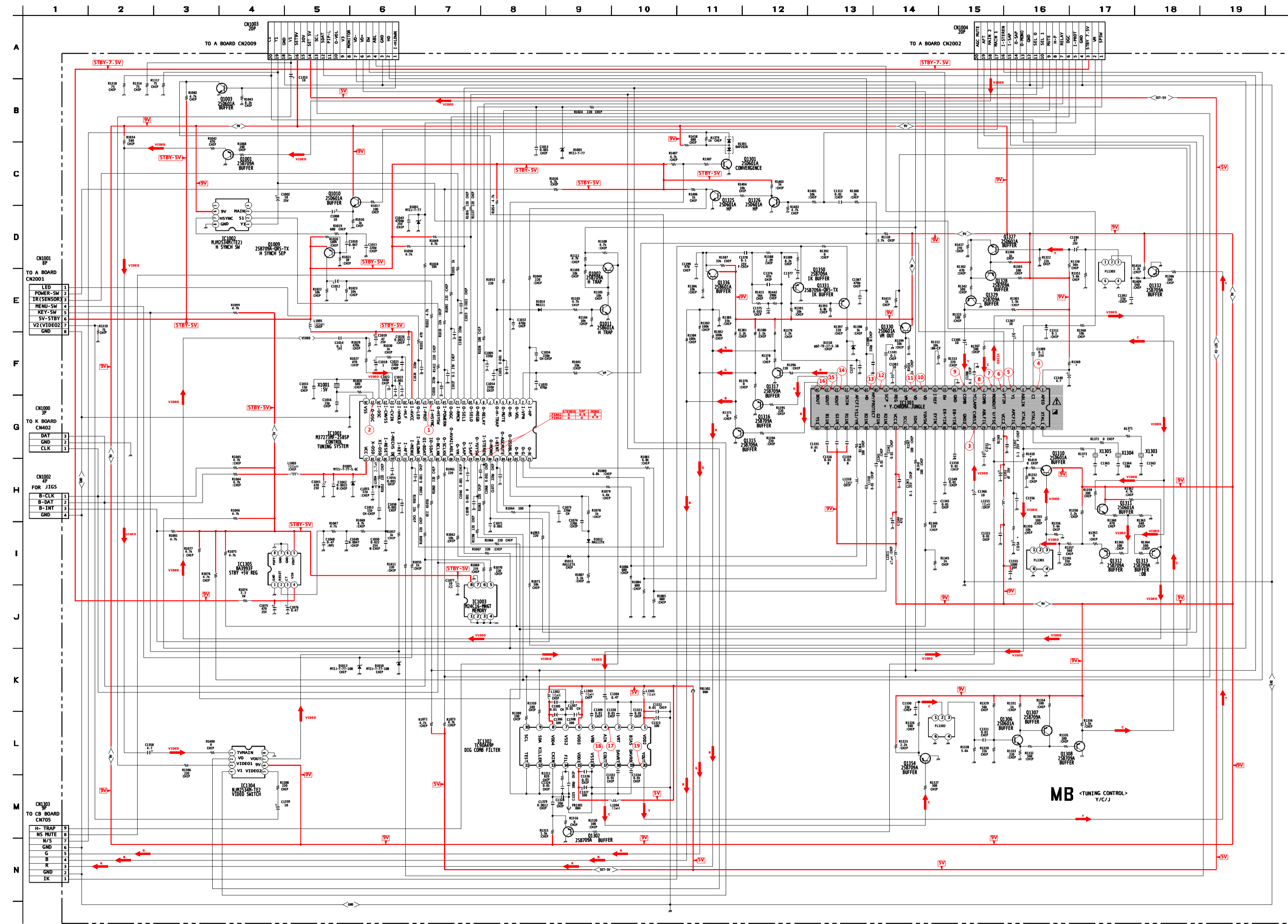

MB BOARD MARK (\*) LIST

REF NO.	LOC.	KV-24FV12 KV-25FV12 KV-25FV12C	KV-25FV12A
C1354	H-16	.47 UF	.22 UF
C1356	H-16	470 PF	220 PF
C1363	G-18	#	18 PF
C1365	G-17	#	18 PF
C1379	F-13	.01 UF	.0047 UF
IC1301	G-14	CXA2131AS	CSA2135S
Q1330	E-14	2SD601A-QRS-TX	2SC2412K-T-146-QR
R1349	G-15	#	0
R1369	F-16	#	4.7 M
R1371	G-17	#	0
R1373	G-17	#	0
R1410	G-16	0	#
X1303	G-18	#	1-579-973-11
X1305	G-17	#	1-579-972-11

MB BOARD TRANSISTOR VOLTAGE LIST

Q1001		Q1011		Q1308		Q1315		Q1327		Q1332	
pin	volt	pin	volt	pin	volt	pin	volt	pin	volt	pin	volt
B	4.8	B	0.0	B	5.7	B	1.4	B	2.4	B	2.4
E	5.4	E	0.0	E	6.3	E	2.0	E	1.8	E	3.0
C	0.0	C	3.5	C	0.0	C	0.0	C	7.6	C	0.0
Q1002		Q1301		Q1310		Q1316		Q1328		Q1336	
pin	volt	pin	volt	pin	volt	pin	volt	pin	volt	pin	volt
B	3.5	B	0.4	B	2.4	B	1.6	B	7.6	B	2.0
E	3.5	E	0.0	E	1.8	E	2.2	E	8.3	E	1.7
C	3.5	C	2.3	C	8.7	C	0.0	C	4.5	C	8.9
Q1003		Q1302		Q1311		Q1317		Q1329		Q1350	
pin	volt	pin	volt	pin	volt	pin	volt	pin	volt	pin	volt
B	0.0	B	4.6	B	0.0	B	1.5	B	4.5	B	2.0
E	0.0	E	5.2	E	3.7	E	2.2	E	5.1	E	1.7
C	5.0	C	0.0	C	8.9	C	0.0	C	0.0	C	8.9
Q1009		Q1306		Q1312		Q1325		Q1330		Q1354	
pin	volt	pin	volt	pin	volt	pin	volt	pin	volt	pin	volt
B	5.2	B	2.4	B	2.0	B	0.6	B	4.9	B	0.0
E	5.0	E	1.8	E	0.0	E	0.0	E	4.3	E	3.2
C	0.8	C	7.5	C	0.0	C	0.7	C	8.9	C	0.0
Q1010		Q1307		Q1313		Q1326		Q1331			
pin	volt	pin	volt	pin	volt	pin	volt	pin	volt	All voltages are in V	
B	4.5	B	0.0	B	4.3	B	0.0	B	3.6		
E	3.8	E	8.2	E	5.0	E	0.0	E	3.6		
C	8.7	C	5.7	C	0.0	C	3.8	C	1.6		

MB BOARD WAVEFORMS

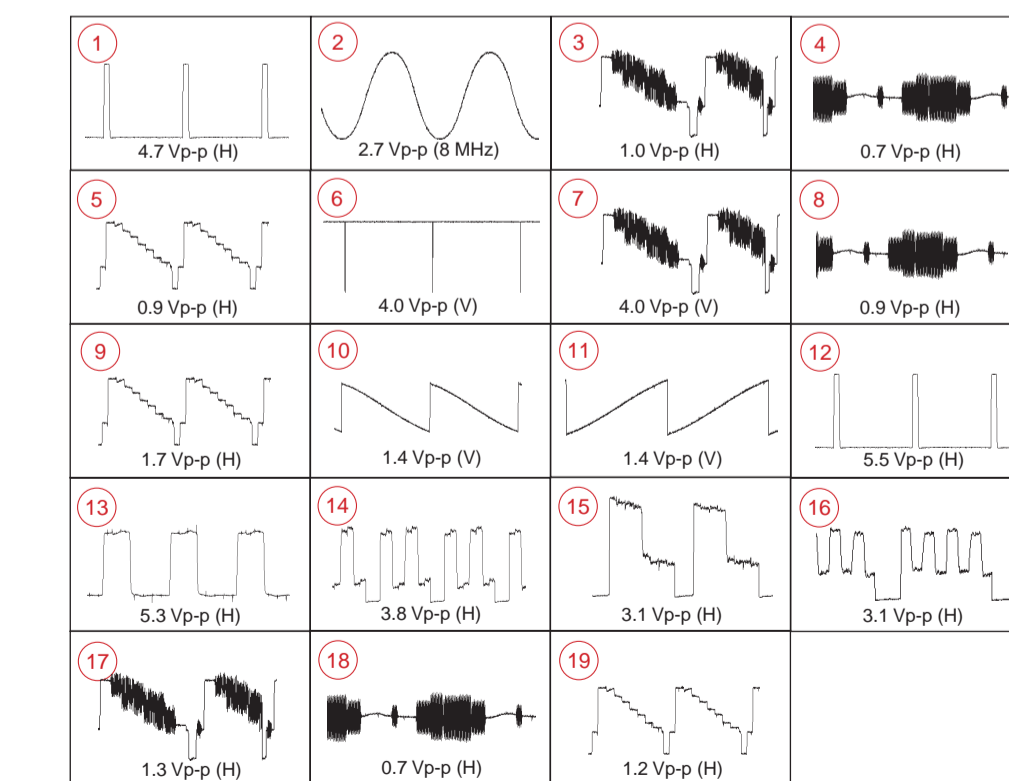



CB BOARD SCHEMATIC DIAGRAM

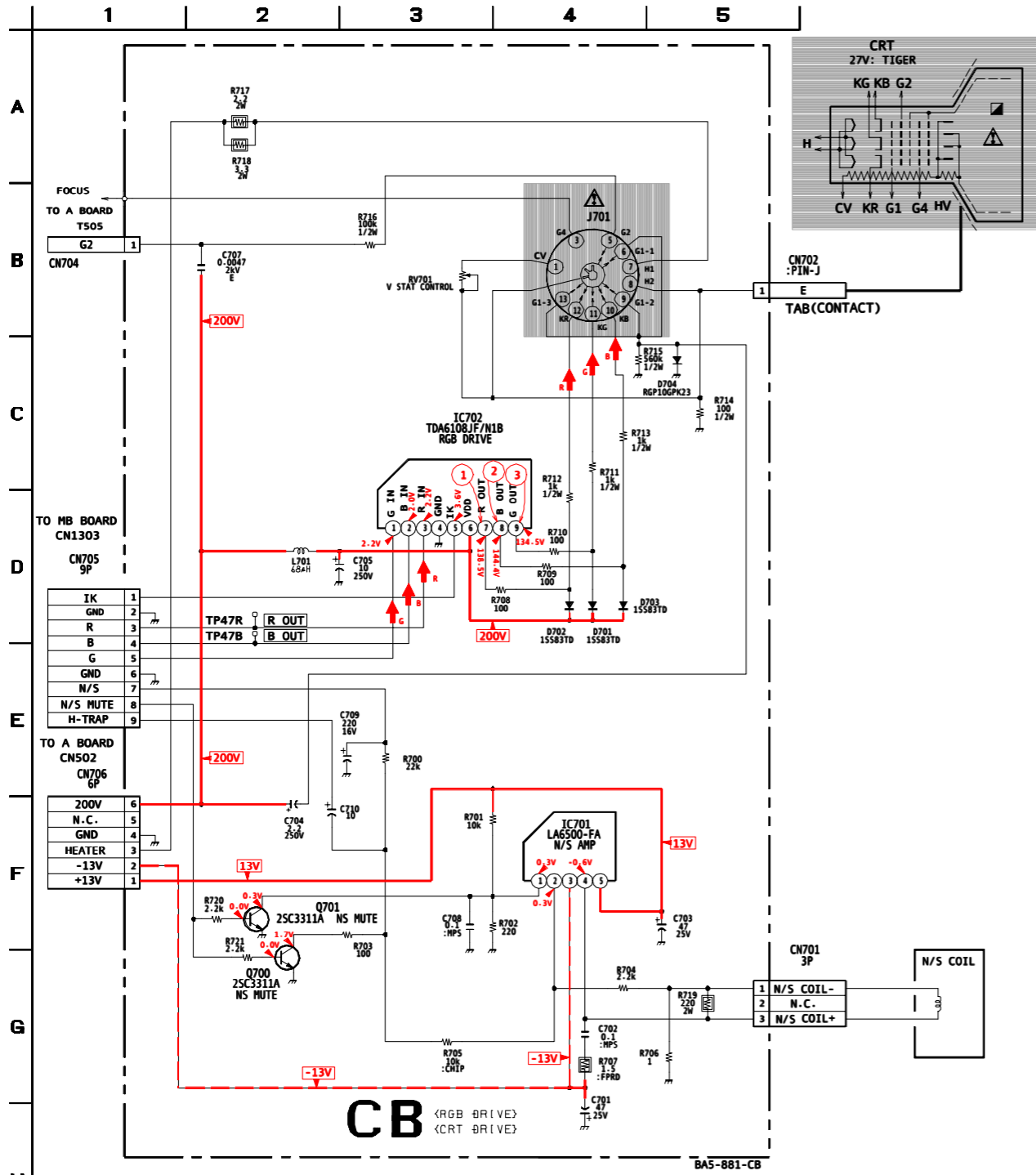

CB BOARD WAVEFORMS

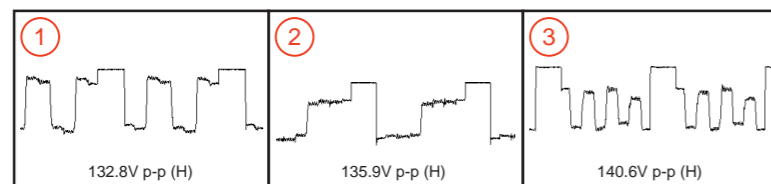

CB [CRT DRIVE, RGB DRIVE]

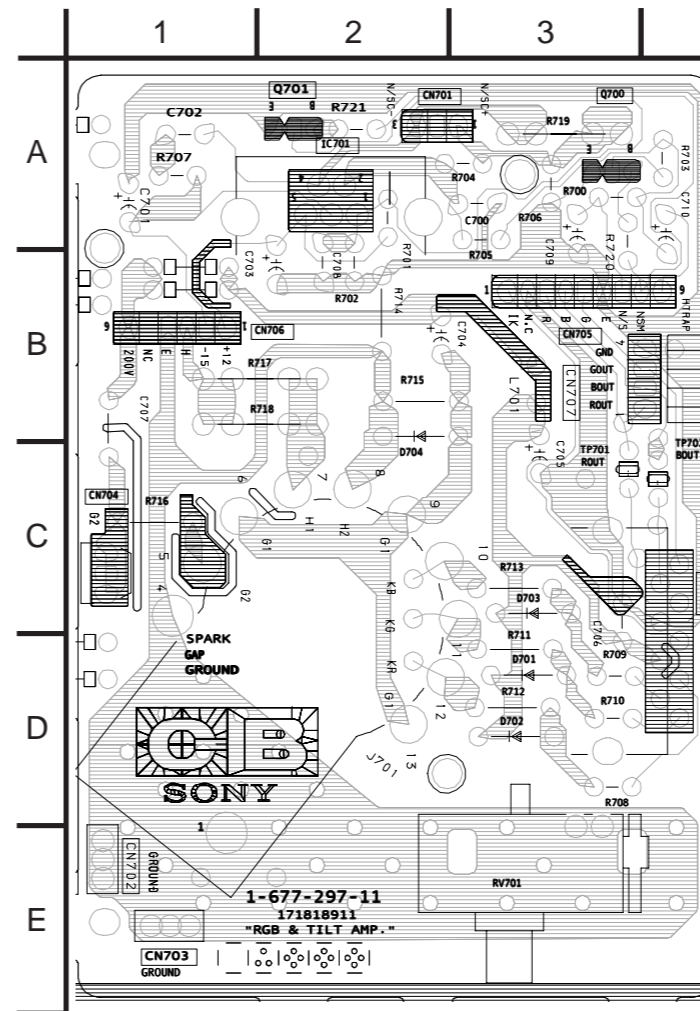

HZ BOARD SCHEMATIC DIAGRAM (KV-25FV12A ONLY)

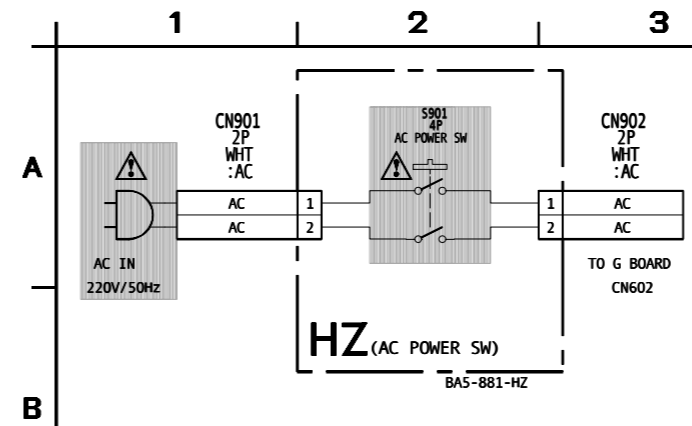

HZ [AC POWER SWITCH] (KV-25FV12A ONLY)

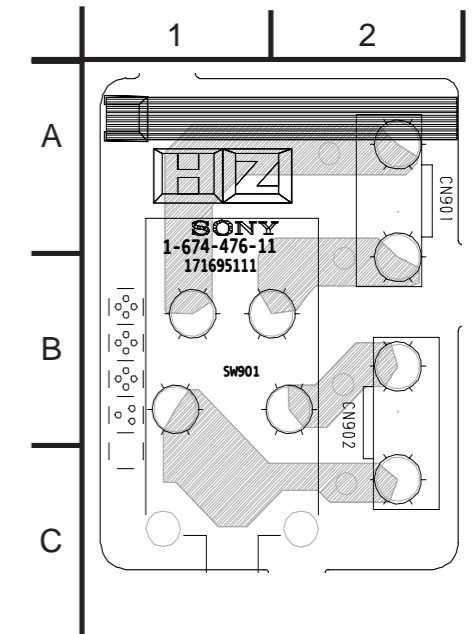

K BOARD SCHEMATIC DIAGRAM

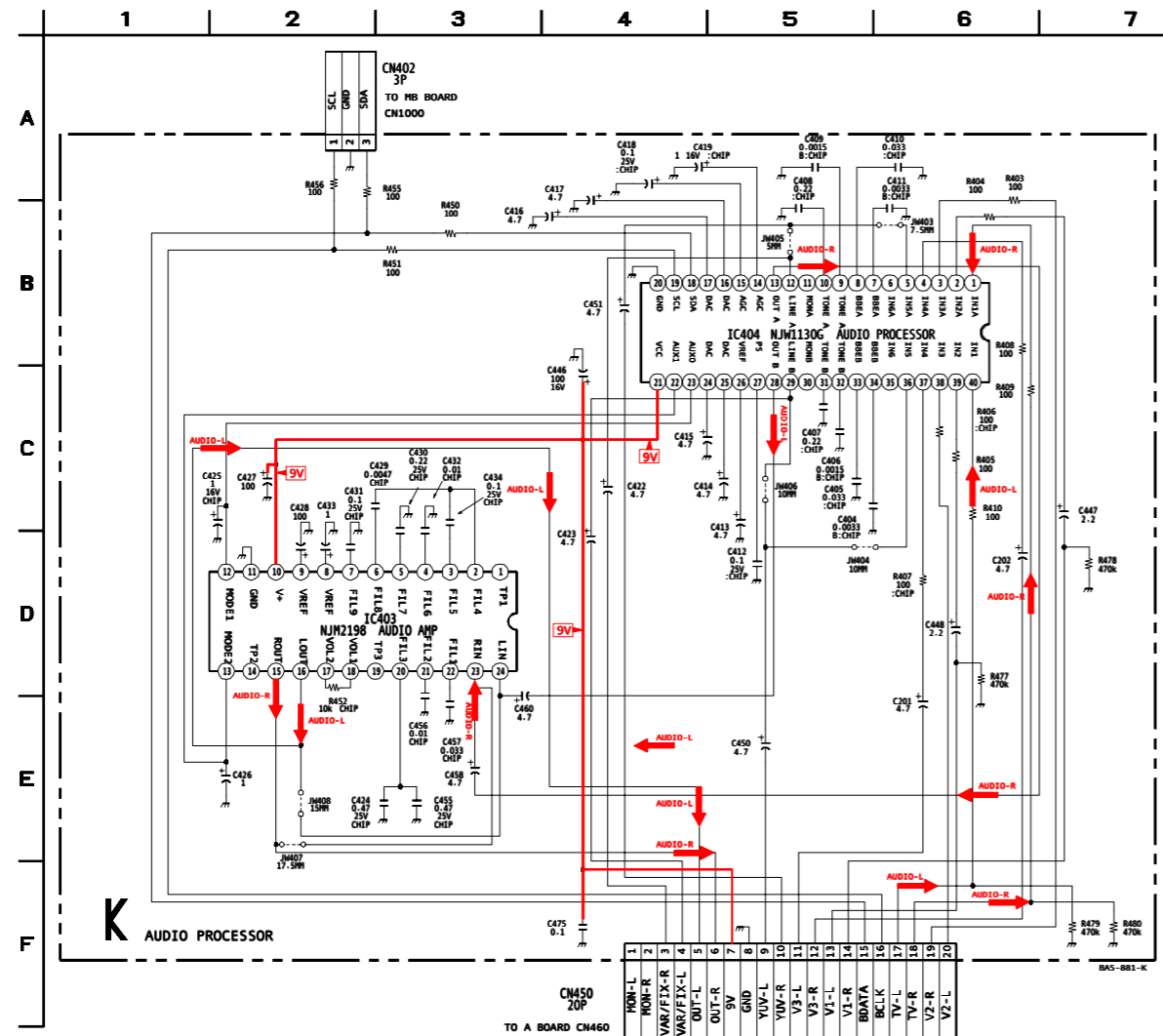

**K** [AUDIO PROCESSOR]

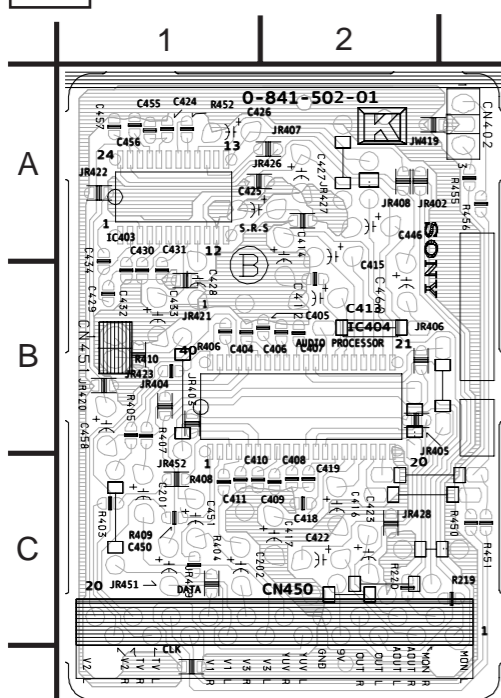

K BOARD IC VOLTAGES

IC403	16	4.5	7	4.7	24	1.3	
pin	volt	17	4.5	8	4.5	25	1.3
1	NC	18	4.5	9	4.5	26	4.4
2	4.5	19	NC	10	4.5	27	3.9
3	4.5	20	4.5	11	NC	28	4.5
4	4.5	21	4.5	12	4.5	29	4.5
5	4.5	22	4.5	13	4.5	30	NC
6	4.5	23	4.5	14	1.0	31	4.5
7	4.5	24	4.5	15	4.5	32	4.5
8	4.5	<b>IC404</b>	16	0.9	33	4.5	
9	4.5	pin	volt	17	0.9	34	4.5
10	9.0	1	4.5	18	4.8	35	NC
11	GND	2	4.5	19	4.9	36	4.5
12	0	3	4.5	20	GND	37	4.5
13	0	4	4.5	21	8.9	38	4.5
14	NC	5	4.5	22	NC	39	4.5
15	4.5	6	NC	23	NC	40	4.5

All voltages are in V

VB BOARD SCHEMATIC DIAGRAM

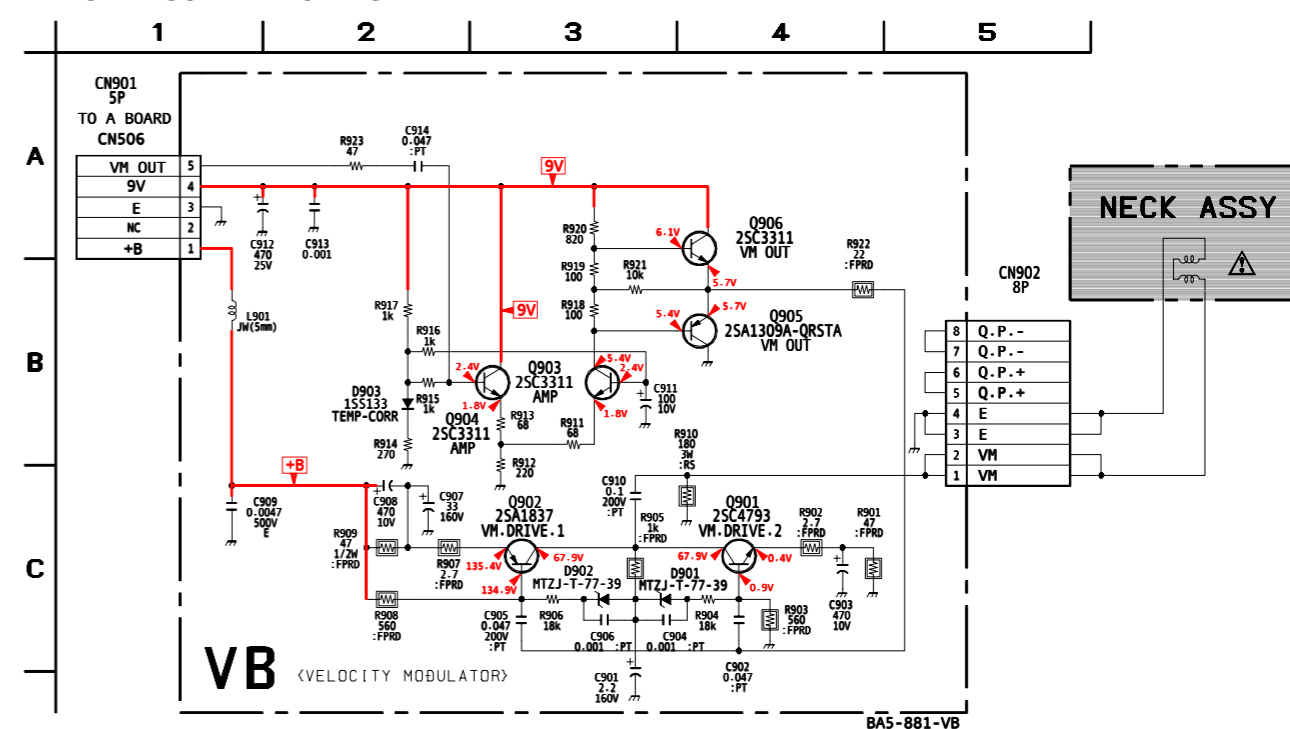

**VB** [VELOCITY MODULATOR]

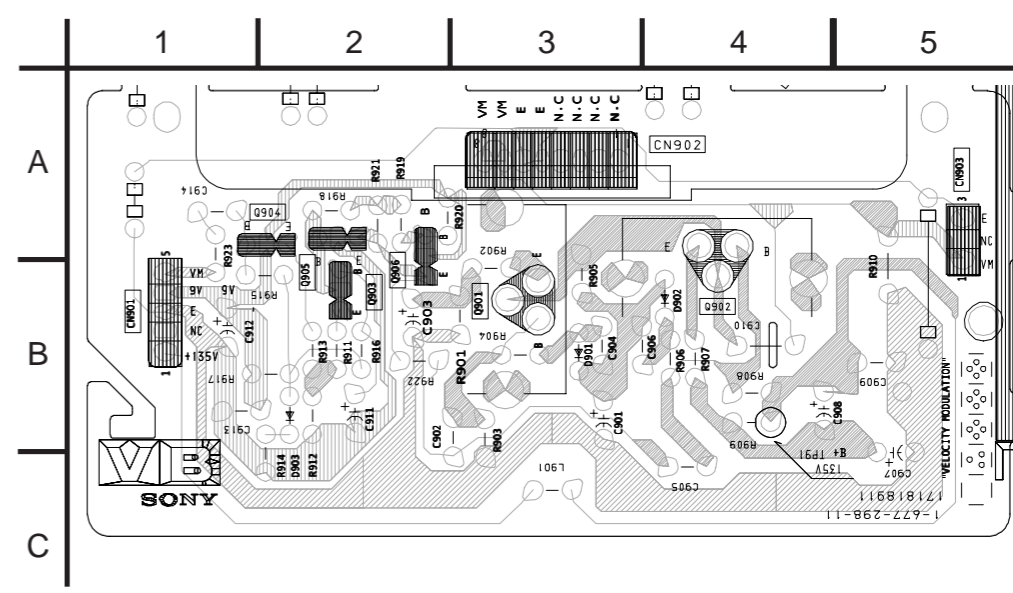

6-4. SEMICONDUCTORS

2SB709A-QRS-TX  
2SD601A-QRS-TX  
2SC2412K-T-146-QR

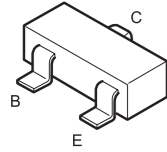

2SC3209LK-TP

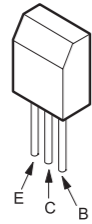

2SC1740S-QRT

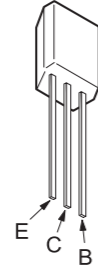

2SA1309A-QRSTA  
2SC3311A-QRSTA  
2SD2144S-TP-UVW

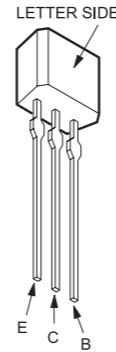

2SA1837  
2SC4159-E

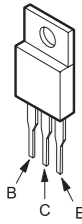

2SA10910-TPE2  
2SA993AS-QRT

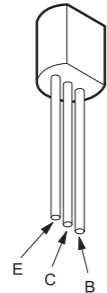

2SK2845-LB102

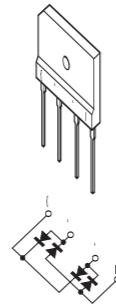

TF541M

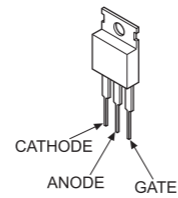

1SS133T-77  
D1N20R-TA  
D1NS4-TA  
MTZJ-T-7712C  
MTZJ-T-77-33B  
MTZJ-T-77-39  
RD8.2ES-T1B

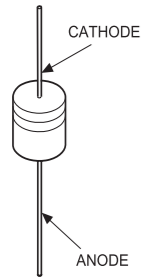

ERC06-15S  
ISS83TD  
MTZJ-T-77-5.1C  
MTZJ-T-775.6C  
MTZJ-T-77-7.5A  
MTZJ-T-77-10B  
MTZJ-T-7730D  
RD10ES-T1B  
RGP10-GPKG3  
RGP02-17PKG23

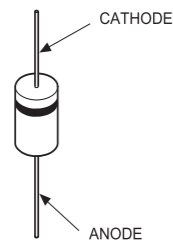

1SS83TD  
D1NL20U-TA  
EL1Z-V1  
ERA22-08TP3  
GP08DPKG23  
RGP10GPKG23  
RU4AM-T3

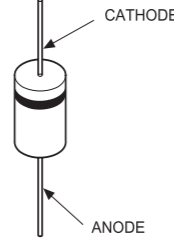

RD9.1EW-T1

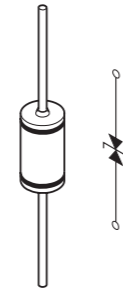

MA111-TX

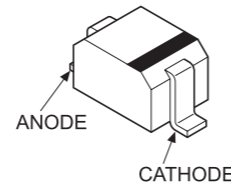

D2SB60A-F04

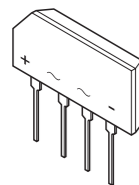

DAP202K-T-146

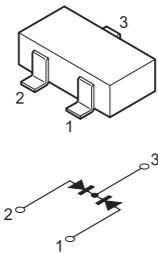

D4SB60L-F

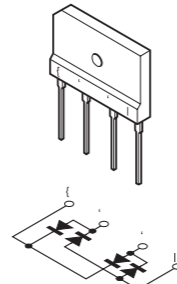

D5LC20U

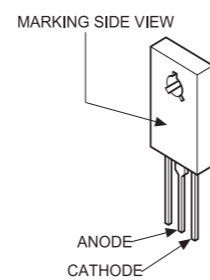

SECTION 7  
EXPLODED VIEW

- Items with no part number and no description are not stocked because they are seldom required for routine service.
- The component parts of an assembly are indicated by the reference numbers in the remarks column.
- Items marked \* are not stocked since they are seldom required for routine service. Some delay should be anticipated when ordering these items.

Note:

The components identified by shading and mark  $\Delta$  are critical for safety. Replace only with part number specified.

Note:

Les composants identifiés par un trame et une marque  $\Delta$  sont critiques pour la sécurité. Ne les remplacer que par une pièce portant le numéro spécifié.

7-1. CHASSIS (KV-24FV12 ONLY)

- 4-041-180-01 SCREW +BVTP 4X12
- ★ 7-685-647-71 SCREW +BVTP 3X10
- 7-685-663-71 SCREW +BVTP 4X16
- ▲ 4-041-268-01 SCREW (7) TAPPING

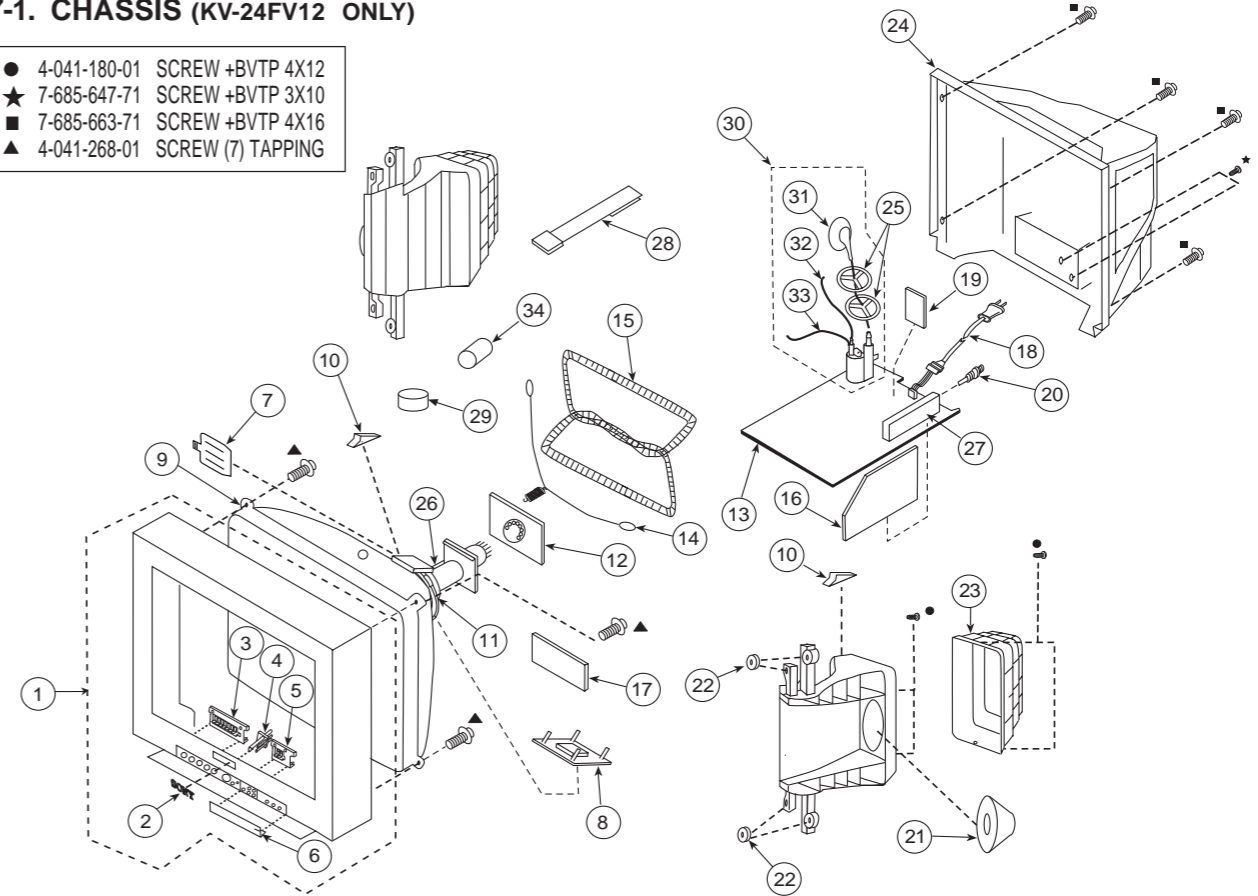

REF. NO.	PART NO.	DESCRIPTION	REMARK	REF. NO.	PART NO.	DESCRIPTION	REMARK
1	X-4036-358-4	BEZNET ASSY	2-6	17	* A-1342-547-A	VB (VAR) MOUNTED PC BOARD	
2	4-046-160-01	EMBLEM (NO.9), SONY		18	$\Delta$ 1-792-874-11	CORD, POWER (WITH CONNECTOR)	
3	4-068-307-04	BUTTON, MULTI		19	* A-1380-629-A	K (VAR) MOUNTED PC BOARD	
4	4-068-308-01	GUIDE, LED		20	1-766-374-11	PLUG, F-PIN	
5	4-068-309-04	BUTTON, FUNCTION		21	1-529-640-11	SPEAKER (13X8CM)	
6	4-068-306-03	DOOR		22	4-374-745-31	CUSHION (A)	
7	4-057-714-01	PIECE ASSY, TLH CORRECTION		23	* 4-068-305-01	BOX, SPEAKER	
8	1-452-896-11	COIL, NA ROTATION (RT200)		24	4-075-094-01	COVER, REAR	
9	$\Delta$ 8-733-250-05	CRT 25RSN		25	3-704-372-71	HOLDER, HV CABLE	
10	4-053-005-01	SPACER, DY		26	$\Delta$ 8-453-011-21	NA299-S	
11	$\Delta$ 1-451-475-11	DEFLECTION YOKE (Y25RSA)		27	$\Delta$ 8-598-431-30	TUNER, FSS BTF-WA411	
12	* A-1332-057-A	CB (VAR) MOUNTED PC BOARD		28	4-062-047-01	PIECE A(110), CONV CORRECT	
13	* A-1299-203-A	A COMPLETE PC BOARD	The high-voltage leads associated with the FBT on this board are not included and must be ordered separately. (See 31-33)	29	1-452-032-00	MAGNET, DISC	
14	4-036-329-01	SPRING (B), TENSION		30	$\Delta$ 1-453-336-11	FBT ASSY NX-4011//X4A4	31-33
15	$\Delta$ 1-419-509-11	COIL, DEGAUSSING		31	1-251-642-52	HV CAP ASSY	
16	* A-1304-193-A	MB (VAR) MOUNTED PC BOARD		32	1-900-800-65	FOCUS LEAD	
				33	1-900-803-22	G2 LEAD	
				34	1-500-586-11	FILTER, CLAMP (FERRITE CORE)	

**Note:**

The components identified by shading and mark  are critical for safety. Replace only with part number specified.





**Note:**

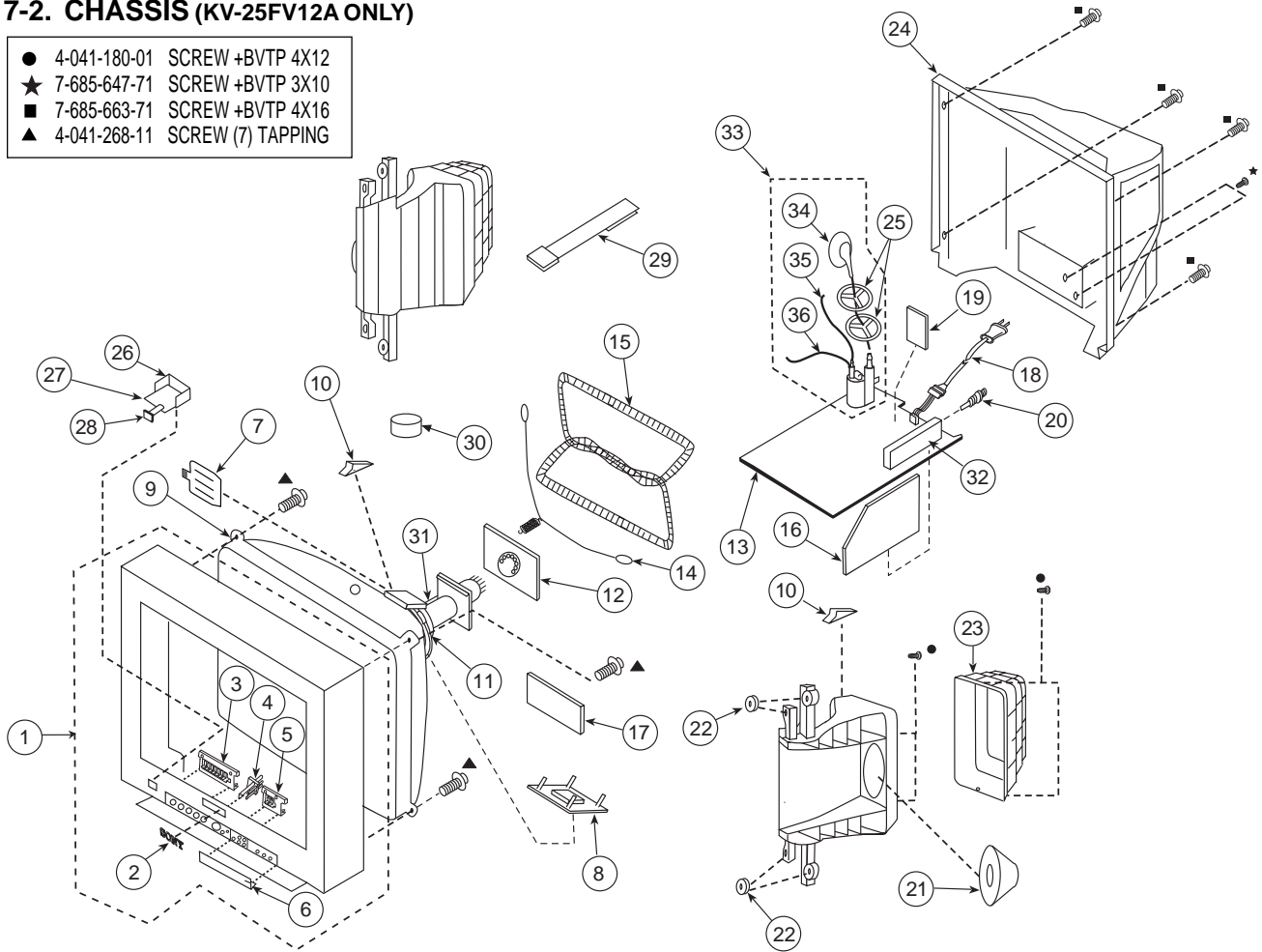

Les composants identifiés par un trame et une marque  sont critiques pour la sécurité. Ne les remplacer que par une pièce portant le numéro spécifié.

**7-2. CHASSIS (KV-25FV12A ONLY)**

- 4-041-180-01 SCREW +BVTP 4X12
- ★ 7-685-647-71 SCREW +BVTP 3X10
- 7-685-663-71 SCREW +BVTP 4X16
- ▲ 4-041-268-11 SCREW (7) TAPPING



REF.NO.	PART.NO.	DESCRIPTION	REMARK
1	X-4037-467-2	BEZNET ASSY	2-6
2	4-046-160-01	EMBLEM (NO.9), SONY	
3	4-068-307-04	BUTTON, MULTI	
4	4-068-308-11	GUIDE, LED	
5	4-068-309-04	BUTTON, FUNCTION	
6	4-068-306-03	DOOR	
7	4-057-714-01	PIECE ASSY, TLH CORRECTION	
8	1-452-896-11	COIL, NA ROTATION (RT200)	
9	 8-733-250-05	CRT 25RSN	
10	4-053-005-01	SPACER, DY	
11	 1-451-475-11	DEFLECTION YOKE (Y25RSA)	
12	* A-1332-057-A	CB (VAR) MOUNTED PC BOARD	
13	* A-1299-205-A	A COMPLETE PC BOARD	The high-voltage leads associated with the FBT on this board are not included and must be ordered separately. (See 34-36)
14	4-036-329-01	SPRING (B), TENSION	
15	 1-419-510-11	COIL, DEGAUSSING	
16	* A-1304-192-A	MB (VAR) MOUNTED PC BOARD	
17	* A-1342-547-A	VB (VAR) MOUNTED PC BOARD	
18	 1-783-838-31	CORD, POWER (WITH CONNECTOR)	

REF.NO.	PART.NO.	DESCRIPTION	REMARK
19	* A-1380-629-A	K (VAR) MOUNTED PC BOARD	
20	1-766-374-11	PLUG, F-PIN	
21	1-529-640-11	SPEAKER (13X8CM)	
22	4-374-745-31	CUSHION (A)	
23	* 4-068-305-01	BOX, SPEAKER	
24	4-075-094-01	COVER, REAR	
25	4-041-203-71	HOLDER, HV CABLE	
26	4-052-635-01	MAIN POWER BRACKET	
27	* A-1372-117-A	MOUNTED PWB, HZ	
28	4-069-764-02	BUTTON, MAIN POWER	
29	4-062-047-01	PIECE A(110), CONV CORRECT	
30	1-452-032-00	MAGNET, DISC	
31	 8-453-011-21	NA299-S	
32	 8-598-431-30	TUNER, FSS BTF-WA411	
33	 1-453-336-11	FBT ASSY NX-4011//X4A4	34-36
34	1-251-642-52	HV CAP ASSY	
35	1-900-800-65	FOCUS LEAD	
36	1-900-803-22	G2 LEAD	

# KV-24FV12/25FV12/25FV12A/25FV12C

**Note:**

The components identified by shading and mark  $\triangle$  are critical for safety. Replace only with part number specified.

**Note:**

Les composants identifiés par un triangle et une marque  $\triangle$  sont critiques pour la sécurité. Ne les remplacer que par une pièce portant le numéro spécifié.

## 7-3. CHASSIS (KV-25FV12/25FV12C ONLY)

- 4-041-180-01 SCREW +BVTP 4X12
- ★ 7-685-647-91 SCREW +BVTP 3X10
- 7-685-663-91 SCREW +BVTP 4X16
- ▲ 4-041-268-01 SCREW (7) TAPPING

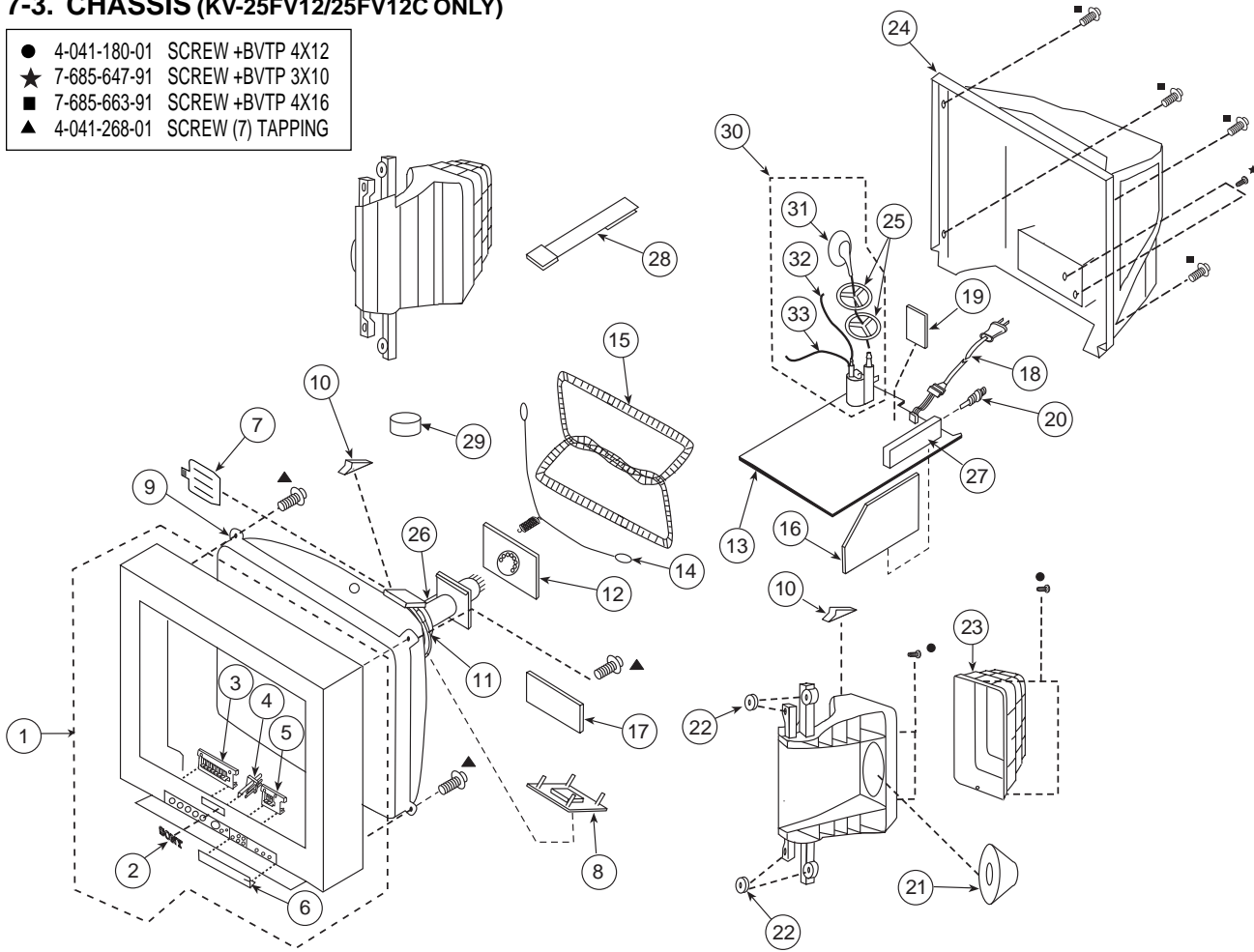

REF.NO.	PART NO.	DESCRIPTION	REMARK	REF.NO.	PART NO.	DESCRIPTION	REMARK
1	X-4036-358-4	BEZNET ASSY	2-6	18	$\triangle$ 1-790-316-21	CORD, AC POWER(WITH CONNECTOR) (KV-25FV12 ONLY)	
2	4-046-160-01	EMBLEM (NO.9), SONY		18	$\triangle$ 1-769-796-31	CORD, POWER (WITH CONNECTOR) (KV-25FV12C ONLY)	
3	4-068-307-04	BUTTON, MULTI		19	* A-1380-629-A	K (VAR) MOUNTED PC BOARD	
4	4-068-308-01	GUIDE, LED		20	1-766-374-11	PLUG, F-PIN	
5	4-068-309-04	BUTTON, FUNCTION		21	1-529-640-11	SPEAKER (13X8CM)	
6	4-068-306-03	DOOR		22	4-374-745-31	CUSHION (A)	
7	4-057-714-01	PIECE ASSY, TLH CORRECTION		23	* 4-068-305-01	BOX, SPEAKER	
8	1-452-896-11	COIL, NA ROTATION (RT200)		24	4-075-094-01	COVER, REAR	
9	$\triangle$ 8-733-250-05	CRT 25RSN		25	3-704-372-71	HOLDER, HV CABLE	
10	4-053-005-01	SPACER, DY		26	$\triangle$ 8-453-011-21	NA299-S	
11	$\triangle$ 1-451-475-11	DEFLECTION YOKE (Y25RSA)		27	$\triangle$ 8-598-431-30	TUNER, FSS BTF-WA411	
12	* A-1332-057-A	CB (VAR) MOUNTED PC BOARD		28	4-062-047-01	PIECE A(110), CONV CORRECT	
13	* A-1299-223-A	A COMPLETE PC BOARD	The high-voltage leads associated with the FBT on this board are not included and must be ordered separately. (See 31-33)	29	1-452-032-00	MAGNET,DISC	
14	4-036-329-01	SPRING (B), TENSION		30	$\triangle$ 1-453-336-11	FBT ASSY NX-4011//X4A4	31-33
15	$\triangle$ 1-419-510-11	COIL, DEGAUSSING		31	1-251-642-52	HV CAP ASSY	
16	* A-1304-193-A	MB (VAR) MOUNTED PC BOARD		32	1-900-800-65	FOCUS LEAD	
17	* A-1342-547-A	VB (VAR) MOUNTED PC BOARD		33	1-900-803-22	G2 LEAD	

## SECTION 8 ELECTRICAL PARTS LIST

A

**Note:**

The components identified by shading and mark  $\triangle$  are critical for safety. Replace only with part number specified.

**Note:**

Les composants identifiés par un trame et une marque  $\triangle$  sont critiques pour la sécurité. Ne les remplacer que par une pièce portant le numéro spécifié.

- The components identified by  $\blacksquare$  in this manual have been carefully factory-selected for each set in order to satisfy regulations regarding X-ray radiation. Should replacement be required, replace only with the value originally used.

- Items marked \* are not stocked since they are seldom required for routine service. Some delay should be anticipated when ordering these items.

- All variable and adjustable resistors have characteristic curve B, unless otherwise noted.

**RESISTORS**

- All resistors are in ohms
- F : nonflammable

When indicating parts by reference number, please include the board name.

REF. NO.	PART NO.	DESCRIPTION	REMARK	REF. NO.	PART NO.	DESCRIPTION	REMARK
<div style="border: 1px solid black; padding: 5px; display: inline-block; font-size: 2em; font-weight: bold;">A</div>							
*	A-1299-203-A	A COMPLETE PC BOARD (KV-24FV12 ONLY)		C439	1-126-940-11	ELECT	330 $\mu$ F 20% 25V
*	A-1299-205-A	A COMPLETE PC BOARD (KV-25FV12A ONLY)		C441	1-164-346-11	CERAMIC CHIP	1 $\mu$ F 16V
*	A-1299-223-A	A COMPLETE PC BOARD (KV-25FV12/25FV12C ONLY)		C442	1-126-963-11	ELECT	4.7 $\mu$ F 20% 50V
<p>The high voltage leads associated with the FBT on this board are not included and must be ordered separately. Order the following leads when requesting this A Board:</p>				C450	1-165-320-11	CERAMIC CHIP	0.47 $\mu$ F 10% 16V
	1-251-642-52	HV CAP ASSY		C501	1-102-112-00	CERAMIC	330PF 10% 50V
	1-900-803-22	G2 LEAD		C502	1-106-383-00	MYLAR	0.047 $\mu$ F 10% 200V
	1-900-800-65	FOCUS LEAD		C503	1-102-212-00	CERAMIC	820PF 10% 500V
	1-533-223-11	HOLDER, FUSE		C504	1-102-002-00	CERAMIC	680PF 10% 500V
*	4-374-846-11	COVER, CAPACITOR, CAP TYPE		C505	1-162-129-00	CERAMIC	150PF 10% 2KV
	4-382-854-11	SCREW (M3X10), P, SW (+)		C506	1-162-318-11	CERAMIC	0.001 $\mu$ F 10% 500V
	4-382-854-11	SCREW (M3X10), P, SW (+)		C507 $\triangle$	1-127-717-11	CAP, METALIZED PP FILM	19000PF
<b>CAPACITOR</b>				C508	1-137-150-11	MYLAR	0.01 $\mu$ F 10% 100V
C100	1-216-295-91	SHORT		C509	1-162-116-00	CERAMIC	680PF 10% 2KV
C101	1-216-295-91	SHORT		C510	1-107-651-11	ELECT	4.7 $\mu$ F 20% 250V
C102	1-126-933-11	ELECT	100 $\mu$ F 20% 16V	C511 $\triangle$	1-115-521-11	FILM	0.82 $\mu$ F 5% 250V
C104	1-126-941-11	ELECT	470 $\mu$ F 20% 25V	C512 $\triangle$	1-106-383-00	MYLAR	0.047 $\mu$ F 10% 200V
C105	1-104-664-11	ELECT	47 $\mu$ F 20% 25V	C513	1-106-343-00	MYLAR	0.001 $\mu$ F 10% 100V
C204	1-163-017-00	CERAMIC CHIP	0.0047 $\mu$ F 10% 50V	C514 $\triangle$	1-117-813-11	FILM	0.75 $\mu$ F 5% 250V
C205	1-126-963-11	ELECT	4.7 $\mu$ F 20% 50V	C515	1-162-116-00	CERAMIC	680PF 10% 2KV
C210	1-126-963-11	ELECT	4.7 $\mu$ F 20% 50V	C516	1-117-214-11	CERAMIC	0.001 $\mu$ F 10% 2KV
C214	1-164-346-11	CERAMIC CHIP	1 $\mu$ F 16V	C520 $\triangle$	1-130-895-00	FILM	0.056 $\mu$ F 10% 400V
C215	1-164-346-11	CERAMIC CHIP	1 $\mu$ F 16V	C521	1-164-646-11	CERAMIC	2200PF 10% 500V
C216	1-126-963-11	ELECT	4.7 $\mu$ F 20% 50V	C523	1-126-941-11	ELECT	470 $\mu$ F 20% 25V
C219	1-126-964-11	ELECT	10 $\mu$ F 20% 50V	C524	1-102-244-00	CERAMIC	220PF 10% 500V
C401	1-126-968-11	ELECT	100 $\mu$ F 20% 50V	C525	1-162-815-11	CERAMIC	47PF 5% 500V
C402	1-126-943-11	ELECT	2200 $\mu$ F 20% 25V	C526	1-126-960-11	ELECT	1 $\mu$ F 20% 50V
C403	1-126-957-11	ELECT	0.22 $\mu$ F 20% 50V	C527	1-126-965-11	ELECT	22 $\mu$ F 20% 50V
C420	1-164-222-11	CERAMIC CHIP	0.22 $\mu$ F 25V	C528	1-164-161-11	CERAMIC CHIP	0.0022 $\mu$ F 10% 50V
C421	1-164-222-11	CERAMIC CHIP	0.22 $\mu$ F 25V	C529	1-164-161-11	CERAMIC CHIP	0.0022 $\mu$ F 10% 50V
C435	1-164-222-11	CERAMIC CHIP	0.22 $\mu$ F 25V	C530	1-163-105-00	CERAMIC CHIP	33PF 5% 50V
C438	1-126-940-11	ELECT	330 $\mu$ F 20% 25V	C531	1-106-387-00	MYLAR	0.068 $\mu$ F 10% 200V
				C533	1-126-941-11	ELECT	470 $\mu$ F 20% 25V
				C534 $\triangle$	1-126-964-11	ELECT	10 $\mu$ F 20% 50V
				C535	1-126-959-11	ELECT	0.47 $\mu$ F 20% 50V
				C537 $\triangle$	1-126-963-11	ELECT	4.7 $\mu$ F 20% 50V
				C539	1-107-645-11	ELECT	22 $\mu$ F 20% 160V
				C540	1-107-645-11	ELECT	22 $\mu$ F 20% 160V
				C541	1-126-969-11	ELECT	220 $\mu$ F 20% 50V
				C542	1-126-967-11	ELECT	47 $\mu$ F 20% 50V

**A****Note:**

The components identified by shading and mark  $\triangle$  are critical for safety. Replace only with part number specified.

**Note:**

Les composants identifiés par un trame et une marque  $\triangle$  sont critiques pour la sécurité. Ne les remplacer que par une pièce portant le numéro spécifié.

REF.NO.	PART NO.	DESCRIPTION	REMARK	REF.NO.	PART NO.	DESCRIPTION	REMARK
C543	1-137-194-81	MYLAR	0.47 $\mu$ F 5% 50V	C644	1-161-964-91	CERAMIC	0.0047 $\mu$ F 250V
C546 $\triangle$	1-107-635-11	ELECT	4.7 $\mu$ F 20% 160V	C645	1-161-964-91	CERAMIC	0.0047 $\mu$ F 250V
C547 $\triangle$	1-163-031-11	CERAMIC CHIP	0.01 $\mu$ F 50V	C646	1-161-964-91	CERAMIC	0.0047 $\mu$ F 250V
C548	1-123-024-21	ELECT	33 $\mu$ F 160V	C647	1-161-964-91	CERAMIC	0.0047 $\mu$ F 250V
C549 $\triangle$	1-126-934-11	ELECT	220 $\mu$ F 20% 16V	C648	1-136-346-21	MYLAR	0.22 $\mu$ F 20% 125V
C550	1-117-661-11	FILM	0.15 $\mu$ F 5% 250V	C652	1-130-471-00	MYLAR	0.001 $\mu$ F 5% 50V
C551	1-137-417-11	MYLAR	0.0047 $\mu$ F 10% 200V	C654	1-107-636-11	ELECT	10 $\mu$ F 20% 160V
C553	1-107-662-11	ELECT	22 $\mu$ F 20% 250V	C655 $\triangle$	1-136-311-11	MYLAR	0.47 $\mu$ F 20% 125V
C601	1-164-004-11	CERAMIC CHIP	0.1 $\mu$ F 10% 25V	C657	1-104-664-11	ELECT	47 $\mu$ F 20% 25V
C602	1-126-967-11	ELECT	47 $\mu$ F 20% 50V	C658	1-135-573-51	ELECT	15000 $\mu$ F 20% 25V
C604	1-164-182-11	CERAMIC CHIP	0.0033 $\mu$ F 10% 50V	C699	1-117-703-11	CERAMIC	0.0047 $\mu$ F 20% 250V
C606 $\triangle$	1-127-795-51	CERAMIC	3300PF 20% 250V	C2001	1-104-664-11	ELECT	47 $\mu$ F 20% 25V
C607 $\triangle$	1-136-311-11	MYLAR	0.47 $\mu$ F 20% 125V	<b>CONNECTOR</b>			
C609	1-126-968-11	ELECT	100 $\mu$ F 20% 50V	CN406 *	1-564-507-11	PLUG, CONNECTOR 4P	
C610	1-126-964-11	ELECT	10 $\mu$ F 20% 50V	CN407	1-900-805-02	CONNECTOR ASSY, 5P BOARD	
C611 $\triangle$	1-127-795-51	CERAMIC	3300PF 20% 250V	CN408	1-900-805-02	CONNECTOR ASSY, 5P BOARD	
C612 $\triangle$	1-128-717-11	ELECT	680 $\mu$ F 20% 250V (KV-24FV12 ONLY)	CN460	1-573-298-21	CONNECTOR, BOARD TO BOARD 20P	
C612 $\triangle$	1-128-718-11	ELECT	560 $\mu$ F 20% 400V (ALL EXCEPT KV-24FV12)	CN501 *	1-580-798-11	CONNECTOR PIN (DY) 6P	
C613	1-126-964-11	ELECT	10 $\mu$ F 20% 50V	CN502 *	1-564-509-11	PLUG, CONNECTOR 6P	
C614	1-130-495-00	MYLAR	0.1 $\mu$ F 5% 50V	CN506 *	1-564-508-11	PLUG, CONNECTOR 5P	
C615	1-130-202-00	FILM	0.022 $\mu$ F 10% 400V (ALL EXCEPT KV-24FV12)	CN601 *	1-508-786-00	PIN, CONNECTOR (5MM PITCH) 2P	
C616	1-107-824-11	CERAMIC	220PF 5% 1KV (ALL EXCEPT KV-24FV12)	CN602 *	1-580-843-11	PIN, CONNECTOR (POWER)	
C617	1-125-893-11	FILM	680PF 3% 1.5KV	CN2001*	1-564-511-11	PLUG, CONNECTOR 8P	
C618	1-164-081-11	CERAMIC	470PF 10% 50V	CN2002	1-573-298-21	CONNECTOR, BOARD TO BOARD 20P	
C619	1-136-356-11	MYLAR	470PF 5% 50V	CN2009	1-573-298-21	CONNECTOR, BOARD TO BOARD 20P	
C620	1-104-665-11	ELECT	100 $\mu$ F 20% 25V	<b>DIODE</b>			
C621	1-125-772-91	CERAMIC	1500PF 10% 2KV	D204	8-719-982-22	DIODE MTZJ-T-77-30D	
C622	1-164-625-11	CERAMIC	680PF 10% 500V	D208	8-719-110-17	DIODE MTZJ-T-77-10B	
C623	1-164-625-11	CERAMIC	680PF 10% 500V	D209	8-719-110-17	DIODE MTZJ-T-77-10B	
C624	1-131-867-51	ELECT	100 $\mu$ F 160V	D210	8-719-110-17	DIODE MTZJ-T-77-10B	
C625	1-135-573-51	ELECT	15000 $\mu$ F 20% 25V	D211	8-719-108-12	DIODE RD9.1EW-T1 (KV-25FV12A ONLY)	
C626	1-135-412-51	ELECT	1000 $\mu$ F 20% 25V	D212	8-719-110-17	DIODE MTZJ-T-77-10B	
C627	1-136-189-00	MYLAR	0.1 $\mu$ F 10% 250V	D213	8-719-110-17	DIODE MTZJ-T-77-10B	
C628	1-104-665-11	ELECT	100 $\mu$ F 20% 25V	D214	8-719-108-12	DIODE RD9.1EW-T1 (KV-25FV12A ONLY)	
C630	1-127-797-51	CERAMIC (KV-24FV12 ONLY)	4700PF 20% 250V	D215	8-719-108-12	DIODE RD9.1EW-T1 (KV-25FV12A ONLY)	
C631	1-127-797-51	CERAMIC (KV-24FV12 ONLY)	4700PF 20% 250V	D230	8-719-118-27	DIODE RD9.1EW-T1	
C634	1-137-605-11	MYLAR	0.01 $\mu$ F 10% 250V	D231	8-719-118-27	DIODE RD9.1EW-T1	
C635	1-163-009-11	CERAMIC CHIP	0.001 $\mu$ F 10% 50V	D400	8-719-118-27	DIODE RD9.1EW-T1	
C636	1-126-970-11	ELECT	330 $\mu$ F 20% 50V	D401	8-719-110-17	DIODE MTZJ-T-77-10B	
C637	1-163-009-11	CERAMIC CHIP	0.001 $\mu$ F 10% 50V	D501	8-719-945-80	DIODE ERC06-15S	
C638	1-163-005-11	CERAMIC CHIP	470PF 10% 50V	D502	8-719-908-03	DIODE GP08DPKG23	
C639	1-126-965-11	ELECT	22 $\mu$ F 20% 50V	D503	8-719-908-03	DIODE GP08DPKG23	
C641	1-107-679-91	ELECT	10 $\mu$ F 20% 450V	D504 $\triangle$	8-719-945-80	DIODE ERC06-15S	
C643	1-104-760-11	CERAMIC CHIP	0.047 $\mu$ F 10% 50V				

**Note:**

The components identified by shading and mark  $\triangle$  are critical for safety. Replace only with part number specified.

**Note:**

Les composants identifiés par un trame et une marque  $\triangle$  sont critiques pour la sécurité. Ne les remplacer que par une pièce portant le numéro spécifié.

A

REF.NO.	PART.NO.	DESCRIPTION	REMARK
D505	$\triangle$ 8-719-312-10	DIODE RU4AM-T3	
D506	8-719-302-43	DIODE RGP10GPKG3	
D507	8-719-991-33	DIODE 1SS133T-77	
D508	8-719-991-33	DIODE 1SS133T-77	
D509	8-719-921-44	DIODE MTZJ-T-77-5.1C	
D510	8-719-908-03	DIODE GP08DPKG23	
D511	8-719-302-43	DIODE RGP10GPKG23	
D513	8-719-979-85	DIODE RGP15GPKG23	
D514	8-719-979-85	DIODE RGP15GPKG23	
D516	$\triangle$ 8-719-991-33	DIODE 1SS133T-77	
D517	$\triangle$ 8-719-991-33	DIODE 1SS133T-77	
D518	$\triangle$ 8-719-110-08	DIODE RD8.2ES-T1B	
D519	$\triangle$ 8-719-302-43	DIODE EL1Z-V1	
D520	$\triangle$ 8-719-073-01	DIODE MA111-TX	
D601	8-719-991-33	DIODE 1SS133T-77	
D602	8-719-991-33	DIODE 1SS133T-77	
D603	8-719-982-26	DIODE MTZJ-T-77-33B	
D604	8-719-028-72	DIODE RGP02-17PKG23	
D605	$\triangle$ 8-719-510-53	DIODE D4SB60L-F	
D606	$\triangle$ 8-719-108-18	DIODE TF541M	
D607	8-719-991-33	DIODE 1SS133T-77	
D608	8-719-110-53	DIODE MTZJ-T-77-20B	
D609	8-719-311-31	DIODE RU-1P (ALL EXCEPT KV-24FV12)	
D610	8-719-510-02	DIODE D1NS4-TA	
D611	8-719-063-70	DIODE D1NL20U-TA	
D612	8-719-110-17	DIODE MTZJ-T-77-10B	
D613	8-719-063-70	DIODE D1NL20U-TA	
D614	8-719-063-70	DIODE D1NL20U-TA	
D615	8-719-312-10	DIODE RU4AM-T3	
D616	8-719-510-37	DIODE D5LC20U	
D617	8-719-110-31	DIODE MTZJ-T-77-12C	
D618	8-719-991-33	DIODE 1SS133T-77	
D619	8-719-110-17	DIODE MTZJ-T-77-10B	
D620	8-719-510-37	DIODE D5LC20U	
D622	8-719-077-76	DIODE D2SB60A-F04	
D623	8-719-948-45	DIODE ERA22-08TP3	
D624	8-719-991-33	DIODE 1SS133T-77	
D625	8-719-991-33	DIODE 1SS133T-77	
D626	8-719-063-70	DIODE D1NL20U-TA	
D627	8-719-110-03	DIODE MTZJ-T-77-7.5A	
D628	8-719-510-48	DIODE D1N20R-TA	
D2001	8-719-070-79	DIODE LNK0220022G1 (KV-25FV12A ONLY)	
D2001	8-719-074-84	DIODE LNK0120022G1 (ALL EXCEPT KV-25FV12A)	
D2002	8-719-110-17	DIODE MTZJ-T-77-10B	
D2003	8-719-108-12	DIODE RD9.1EW-T1	
D2004	8-719-921-44	DIODE MTZJ-T-77-5.1C	
D2005	8-719-921-44	DIODE MTZJ-T-77-5.1C	

**REF.NO. PART.NO. DESCRIPTION REMARK****FUSE**

F601	$\triangle$ 1-576-193-11	FUSE 6.3A/125V (KV-24FV12 ONLY)	
F601	$\triangle$ 1-532-506-51	FUSE 6.3A/250V (ALL EXCEPT KV-24FV12)	

**FERRITE BEAD**

FB501	1-410-397-21	FERRITE	1.1 $\mu$ H
FB502	1-410-397-21	FERRITE	1.1 $\mu$ H
FB503	1-410-397-21	FERRITE	1.1 $\mu$ H
FB600	1-412-911-11	FERRITE	0 $\mu$ H
FB601	1-412-911-11	FERRITE	0 $\mu$ H
FB602	1-412-911-11	FERRITE	0 $\mu$ H
FB603	1-412-911-11	FERRITE	0 $\mu$ H
FB604	1-412-911-11	FERRITE	0 $\mu$ H
FB605	1-412-911-11	FERRITE	0 $\mu$ H
FB606	1-412-911-11	FERRITE	0 $\mu$ H
FB609	1-412-911-11	FERRITE	0 $\mu$ H
FB610	1-412-911-11	FERRITE	0 $\mu$ H

**IC**

IC402	8-759-573-40	IC TDA8580Q/N1	
IC501	$\triangle$ 8-759-700-07	IC NJM2903M-TE2	
IC502	8-759-980-58	IC TDA8172	
IC601	$\triangle$ 8-749-015-61	IC STR-F6626 (KV-24FV12 ONLY)	
IC601	$\triangle$ 8-749-014-48	IC STR-F6656 (ALL EXCEPT KV-24FV12)	
IC602	$\triangle$ 8-749-016-47	IC EA135-F12	
IC603	8-759-198-03	IC PQ09RF21	
IC604	8-759-701-75	IC NJM7805FA	
IC2001	8-742-134-00	HYB IC SBX1981-51P	

**JACK**

J201	1-794-119-11	TERMINAL BLOCK, S 4P	
J202	1-794-267-11	JACK, PIN 3P	
J205	1-794-116-11	JACK BLOCK, PIN 2P	
J401	1-568-267-21	JACK	

**CHIP CONDUCTOR**

JR001	1-216-295-91	SHORT	
JR002	1-216-295-91	SHORT	
JR403	1-216-295-91	SHORT	
JR405	1-216-295-91	SHORT	
JR411	1-216-295-91	SHORT	
JR413	1-216-295-91	SHORT	
JR430	1-216-295-91	SHORT	

**A****Note:**

The components identified by shading and mark  $\triangle$  are critical for safety. Replace only with part number specified.

**Note:**

Les composants identifiés par un trame et une marque  $\triangle$  sont critiques pour la sécurité. Ne les remplacer que par une pièce portant le numéro spécifié.

REF.NO.	PART NO.	DESCRIPTION	REMARK	REF.NO.	PART NO.	DESCRIPTION	REMARK
JR471	1-216-295-91	SHORT					
JR503	1-216-295-91	SHORT					
<b>COIL</b>							
L101	1-414-267-11	INDUCTOR	10 $\mu$ H	R101	1-216-073-00	RES-CHIP	10K 5% 1/10W
L102	1-414-273-11	INDUCTOR	100 $\mu$ H	R105	1-216-065-91	RES-CHIP	4.7K 5% 1/10W
L103	1-414-267-11	INDUCTOR	10 $\mu$ H	R107	1-216-025-91	RES-CHIP	100 5% 1/10W
L501 $\triangle$	1-409-955-11	INDUCTOR	8mH	R108	1-216-025-91	RES-CHIP	100 5% 1/10W
L502	1-412-552-11	INDUCTOR	2.2mH	R115	1-216-295-91	SHORT	
L503	1-406-677-11	INDUCTOR	10mH	R204	1-216-083-00	RES-CHIP	27K 5% 1/10W
L504	1-412-533-21	INDUCTOR	47 $\mu$ H	R205	1-216-689-11	RES-CHIP	39K 5% 1/10W
L505	1-406-978-11	INDUCTOR	150 $\mu$ H	R208	1-215-899-11	METAL OXIDE	15K 5% 2W
L506	1-406-677-11	INDUCTOR	10mH	R214	1-216-113-00	RES-CHIP	470K 5% 1/10W
L510	1-412-528-11	INDUCTOR	18 $\mu$ H	R215	1-216-113-00	RES-CHIP	470K 5% 1/10W
L603	1-412-529-11	INDUCTOR	22 $\mu$ H	R235	1-216-089-91	RES-CHIP	47K 5% 1/10W
L604	1-412-525-31	INDUCTOR	10 $\mu$ H	R237	1-216-033-00	RES-CHIP	220 5% 1/10W
L605	1-412-529-11	INDUCTOR	22 $\mu$ H	R238	1-216-033-00	RES-CHIP	220 5% 1/10W
<b>PHOTO COUPLER</b>				R239	1-216-089-91	RES-CHIP	47K 5% 1/10W
PH601 $\triangle$	8-749-010-64	PHOTO COUPLER PC123FY2		R401	1-216-080-00	RES-CHIP	20K 5% 1/10W
<b>IC LINK</b>				R402	1-216-073-00	RES-CHIP	10K 5% 1/10W
PS401 $\triangle$	1-532-686-21	LINK, IC 2.7A/150V		R412	1-216-113-00	RES-CHIP	470K 5% 1/10W
<b>TRANSISTOR</b>				R413	1-216-113-00	RES-CHIP	470K 5% 1/10W
Q101	8-729-422-27	TRANSISTOR 2SD601A-QRS-TX		R421	1-249-425-11	CARBON	4.7K 5% 1/4W
Q410	8-729-422-27	TRANSISTOR 2SD601A-QRS-TX		R422	1-249-389-11	CARBON	4.7 5% 1/4W
Q411	8-729-216-22	TRANSISTOR 2SB709A-QRS-TX		R426	1-216-009-91	RES-CHIP	22 5% 1/10W
Q501	8-729-140-50	TRANSISTOR 2SC3209LK-TP		R427	1-247-815-91	CARBON	220 5% 1/4W
Q502 $\triangle$	8-729-046-07	TRANSISTOR 2SD2578-YB		R428	1-216-033-00	RES-CHIP	220 5% 1/10W
Q503 $\triangle$	8-729-422-27	TRANSISTOR 2SD601A-QRS-TX		R429	1-216-113-00	RES-CHIP	470K 5% 1/10W
Q504	8-729-809-29	TRANSISTOR 2SC4159-E		R430	1-216-049-91	RES-CHIP	1K 5% 1/10W
Q505 $\triangle$	8-729-200-17	TRANSISTOR 2SA1091O-TPE2		R431	1-216-049-91	RES-CHIP	1K 5% 1/10W
Q506 $\triangle$	8-729-422-27	TRANSISTOR 2SD601A-QRS-TX		R432	1-216-085-00	RES-CHIP	33K 5% 1/10W
Q507 $\triangle$	8-729-216-22	TRANSISTOR 2SB709A-QRS-TX		R433	1-216-113-00	RES-CHIP	470K 5% 1/10W
Q601	8-729-922-37	TRANSISTOR 2SD2144S-TP-UVW		R436	1-216-073-00	RES-CHIP	10K 5% 1/10W
Q602	8-729-423-33	TRANSISTOR 2SC3311A-QRSTA		R437	1-216-073-00	RES-CHIP	10K 5% 1/10W
Q603	8-729-119-76	TRANSISTOR 2SA1309A-QRSTA		R438	1-216-073-00	RES-CHIP	10K 5% 1/10W
Q604	8-729-422-27	TRANSISTOR 2SD601A-QRS-TX		R439	1-216-073-00	RES-CHIP	10K 5% 1/10W
Q605 $\triangle$	8-729-046-40	TRANSISTOR 2SK2663		R440	1-216-097-91	RES-CHIP	100K 5% 1/10W
Q606	8-729-422-27	TRANSISTOR 2SD601A-QRS-TX		R441	1-216-081-00	RES-CHIP	22K 5% 1/10W
Q607	8-729-922-37	TRANSISTOR 2SD2144S-TP-UVW		R442	1-216-025-91	RES-CHIP	100 5% 1/10W
Q608	8-729-422-27	TRANSISTOR 2SD601A-QRS-TX		R445	1-216-073-00	RES-CHIP	10K 5% 1/10W
Q609	8-729-423-33	TRANSISTOR 2SC3311A-QRSTA		R446	1-249-435-11	CARBON	33K 5% 1/4W
				R447	1-216-065-91	RES-CHIP	4.7K 5% 1/10W
				R454	1-216-025-91	RES-CHIP	100 5% 1/10W
				R501	1-247-843-11	CARBON	3.3K 5% 1/4W
				R502 $\triangle$	1-216-480-11	METAL OXIDE	820 5% 3W
				R503 $\triangle$	1-249-426-11	CARBON	5.6K 5% 1/4W
				R506 $\triangle$	1-215-885-00	METAL OXIDE	68 5% 2W
				R507 $\triangle$	1-260-328-11	CARBON	1K 5% 1/2W
				R508	1-247-863-91	CARBON	22K 5% 1/4W
				R509 $\triangle$	1-216-480-11	METAL OXIDE	820 5% 3W
				R510	1-249-411-11	CARBON	330 5% 1/4W
				R513 $\triangle$	1-215-908-21	METAL OXIDE	33 5% 3W

## Note:

The components identified by shading and mark  $\triangle$  are critical for safety. Replace only with part number specified.

## Note:

The components identified by  $\boxtimes$  in this manual have been carefully factory-selected for each set in order to satisfy regulations regarding x-ray radiation. Should replacement be required, replace only with the value originally used.

A

REF.NO.	PART NO.	DESCRIPTION	REMARK	REF.NO.	PART NO.	DESCRIPTION	REMARK
R516	1-249-429-11	CARBON	10K 5% 1/4W	R601	$\triangle$ 1-219-513-11	CARBON (KV-24FV12 ONLY)	4.7M 5% 1/2W
R517	1-249-429-11	CARBON	10K 5% 1/4W	R602	$\triangle$ 1-249-389-11	CARBON	4.7 5% 1/4W
R518	1-249-429-11	CARBON	10K 5% 1/4W	R603	1-215-485-00	METAL	470K 1% 1/4W
R519	1-249-429-11	CARBON	10K 5% 1/4W	R607	1-215-859-00	METAL OXIDE	22 5% 1W
R520	$\triangle$ 1-215-861-00	METAL OXIDE	47 5% 1W	R608	1-240-205-11	CARBON	22M 5% 1/2W
R521	1-249-411-11	CARBON	330 5% 1/4W	R609	1-216-049-91	RES-CHIP	1K 5% 1/10W
R522	1-249-415-11	CARBON	680 5% 1/4W	R610	1-216-073-00	RES-CHIP	10K 5% 1/10W
R523	1-216-073-00	RES-CHIP	10K 5% 1/10W	R611	1-216-089-91	RES-CHIP	47K 5% 1/10W
R524	1-249-429-11	CARBON	10K 5% 1/4W	R612	1-216-045-00	RES-CHIP	680 5% 1/10W
R525	$\triangle$ 1-216-069-00	RES-CHIP	6.8K 5% 1/10W	R613	$\triangle$ 1-219-512-11	CARBON	2.2M 5% 1/2W
R526	1-208-814-91	METAL CHIP	22K 1% 1/10W	R614	1-249-413-11	CARBON	470 5% 1/4W
R527	1-216-079-00	RES-CHIP	18K 5% 1/10W	R615	$\triangle$ 1-218-265-11	METAL (ALL EXCEPT KV-24FV12)	8.2M 5% 1W
R528	1-249-421-11	CARBON	2.2K 5% 1/4W	R616	$\triangle$ 1-260-302-51	CARBON	6.8 5% 1/2W
R529	1-216-113-00	RES-CHIP	470K 5% 1/10W	R617	1-216-009-91	RES-CHIP	22 5% 1/10W
R530	1-216-081-00	RES-CHIP	22K 5% 1/10W	R618	1-249-440-11	CARBON	82K 5% 1/4W
R532	1-215-437-00	METAL	4.7K 1% 1/4W	R619	1-249-437-11	CARBON	47K 5% 1/4W
R533	1-215-461-00	METAL	47K 1% 1/4W	R620	1-249-417-11	CARBON	1K 5% 1/4W
R534	1-215-451-00	METAL	18K 1% 1/4W	R621	$\triangle$ 1-240-251-11	CEMENTED	6.8 5% 10W
R535	1-249-441-11	CARBON	100K 5% 1/4W	R622	1-249-441-11	CARBON	100K 5% 1/4W
R536	$\triangle$ 1-216-351-00	METAL OXIDE	1.5 5% 1W	R623	$\triangle$ 1-260-324-11	CARBON	470 5% 1/2W
R538	$\triangle$ 1-215-890-11	METAL OXIDE	470 5% 2W	R624	$\triangle$ 1-249-429-11	CARBON	10K 5% 1/4W
R539	1-249-385-11	CARBON	2.2 5% 1/4W	R625	1-249-437-11	CARBON	47K 5% 1/4W
R540	1-215-445-00	METAL	10K 1% 1/4W	R626	$\triangle$ 1-220-926-11	FUSIBLE	0.47 10% 1/2W
R541	1-249-429-11	CARBON	10K 5% 1/4W	R627	1-215-483-00	METAL (KV-24FV12 ONLY)	390K 1% 1/4W
R543	1-247-887-00	CARBON	220K 5% 1/4W	R627	1-215-479-00	METAL (ALL EXCEPT KV-24FV12)	270K 1% 1/4W
R544	1-260-312-11	CARBON	47 5% 1/2W	R628	1-215-479-00	METAL (ALL EXCEPT KV-24FV12)	270K 1% 1/4W
R546	$\triangle$ 1-249-377-11	CARBON	0.47 5% 1/4W	R630	1-249-421-11	CARBON	2.2K 5% 1/4W
R549	$\triangle$ 1-260-288-11	CARBON	0.47 5% 1/2W	R631	1-215-929-11	METAL OXIDE (ALL EXCEPT KV-24FV12)	100K 5% 3W
R550	$\triangle$ 1-260-288-11	CARBON	0.47 5% 1/2W	R632	$\triangle$ 1-216-361-21	METAL OXIDE	0.22 5% 2W
R552	$\triangle$ 1-215-910-00	METAL OXIDE	68 5% 3W	R633	1-249-415-11	CARBON	680 5% 1/4W
R553	$\triangle$ 1-216-365-00	METAL OXIDE	0.47 5% 2W	R634	1-216-073-00	RES-CHIP	10K 5% 1/10W
R554	$\triangle$ 1-249-429-11	CARBON	10K 5% 1/4W	R635	1-216-057-00	RES-CHIP	2.2K 5% 1/10W
R555	$\triangle$ 1-247-895-91	CARBON	470K 5% 1/4W	R637	$\triangle$ 1-216-485-11	METAL OXIDE (ALL EXCEPT KV-24FV12)	5.6K 5% 3W
R556	$\triangle$ 1-249-418-11	CARBON	1.2K 5% 1/4W	R638	1-249-399-11	CARBON (KV-24FV12 ONLY)	33 5% 1/4W
R557	$\triangle$ 1-247-895-91	CARBON	470K 5% 1/4W	R638	1-249-402-11	CARBON (ALL EXCEPT KV-24FV12)	56 5% 1/4W
R558	$\triangle$ 1-216-097-91	RES-CHIP	100K 5% 1/10W	R639	1-249-421-11	CARBON	2.2K 5% 1/4W
R559	$\triangle$ 1-216-073-00	RES-CHIP	10K 5% 1/10W	R640	1-249-417-11	CARBON	1K 5% 1/4W
R560	$\triangle$ 1-215-902-11	METAL OXIDE	47K 5% 1W	R641	$\triangle$ 1-216-362-11	METAL OXIDE	0.27 5% 2W
R561	$\triangle$ 1-215-416-00	METAL	620 1% 1/4W	R642	1-216-089-91	RES-CHIP	47K 5% 1/10W
R562	$\triangle$ 1-208-806-11	METAL CHIP	10K 1% 1/10W	R643	1-249-419-11	CARBON	1.5K 5% 1/4W
R563	$\triangle$ 1-249-441-11	CARBON	100K 5% 1/4W	R644	1-247-843-11	CARBON	3.3K 5% 1/4W
$\boxtimes$ R564	$\triangle$ 1-208-828-11	METAL CHIP	82K 1% 1/10W	R645	1-215-898-11	METAL OXIDE	10K 5% 2W
R565	$\triangle$ 1-249-429-11	CARBON	10K 5% 1/4W				
R566	$\triangle$ 1-216-073-00	RES-CHIP	10K 5% 1/10W				
R567	$\triangle$ 1-216-073-00	RES-CHIP	10K 5% 1/10W				
R568	$\triangle$ 1-215-882-00	METAL OXIDE	22 5% 2W				
R571	1-216-065-91	RES-CHIP	4.7K 5% 1/10W				
R572	1-216-065-91	RES-CHIP	4.7K 5% 1/10W				

A	CB
---	----

**Note:**

The components identified by shading and mark  $\triangle$  are critical for safety. Replace only with part number specified.

**Note:**

Les composants identifiés par un trame et une marque  $\triangle$  sont critiques pour la sécurité. Ne les remplacer que par une pièce portant le numéro spécifié.

REF.NO.	PART NO.	DESCRIPTION	REMARK			
R646	1-249-419-11	CARBON	1.5K	5%	1/4W	
R648	1-215-908-21	METAL OXIDE	33	5%	3W	
R649	1-249-417-11	CARBON	1K	5%	1/4W	
R650	1-216-387-11	METAL OXIDE	0.68	5%	3W	
R651	1-249-429-11	CARBON	10K	5%	1/4W	
R653	1-216-049-91	RES-CHIP	1K	5%	1/10W	
R655	1-216-049-91	RES-CHIP	1K	5%	1/10W	
R656	1-249-429-11	CARBON	10K	5%	1/4W	
R658	1-216-387-11	METAL OXIDE	0.68	5%	3W	
R659	1-215-857-11	METAL OXIDE	10	5%	1W	
R660	$\triangle$ 1-215-924-00	METAL OXIDE (KV-24FV12 ONLY)	15K	5%	3W	
R660	$\triangle$ 1-216-485-11	METAL OXIDE (ALL EXCEPT KV-24FV12)	5.6K	5%	3W	
R661	1-216-057-00	RES-CHIP	2.2K	5%	1/10W	
R662	$\triangle$ 1-216-485-11	METAL OXIDE (ALL EXCEPT KV-24FV12)	5.6K	5%	3W	
R663	1-216-081-00	RES-CHIP	22K	5%	1/10W	
R2001	1-216-057-00	RES-CHIP	2.2K	5%	1/10W	
R2002	1-216-053-00	RES-CHIP	1.5K	5%	1/10W	
R2003	1-249-425-11	CARBON	4.7K	5%	1/4W	
R2004	1-216-069-00	RES-CHIP	6.8K	5%	1/10W	
R2006	1-216-295-91	SHORT (KV-25FV12A ONLY)				
R2007	1-249-413-11	CARBON (KV-25FV12A ONLY)	470	5%	1/4W	
R2011	1-249-415-11	CARBON	680	5%	1/4W	
R2012	1-249-416-11	CARBON	820	5%	1/4W	
R2013	1-249-421-11	CARBON	2.2K	5%	1/4W	
R2014	1-249-427-11	CARBON	6.8K	5%	1/4W	

**RELAY**

RY601	$\triangle$ 1-755-198-11	RELAY
RY602	$\triangle$ 1-755-266-11	RELAY, AC POWER

**SWITCH**

S2001	1-692-431-21	SWITCH, TACTILE
S2002	1-692-431-21	SWITCH, TACTILE
S2003	1-692-431-21	SWITCH, TACTILE
S2004	1-692-431-21	SWITCH, TACTILE
S2005	1-692-431-21	SWITCH, TACTILE
S2006	1-692-431-21	SWITCH, TACTILE
S2007	1-762-816-11	SWITCH, TACTILE
S2008	1-762-816-11	SWITCH, TACTILE

**SWITCH**

SW502	1-572-707-11	SWITCH, LEVER
-------	--------------	---------------

REF.NO.	PART NO.	DESCRIPTION	REMARK
<b>TRANSFORMER</b>			
T501	$\triangle$ 1-437-195-11	TRANSFORMER, HORIZONTAL DRIVE	
T503	1-426-981-11	TRANSFORMER, FERRITE (PMT)	
T504	$\triangle$ 1-431-693-11	TRANSFORMER, HORIZONTAL LINEAR	
T505	$\triangle$ 1-453-336-11	FBT ASSY NX-4011//X	
T602	$\triangle$ 1-426-717-11	TRANSFORMER, LINE FILTER (LFT) (KV-24FV12 ONLY)	
T602	$\triangle$ 1-435-617-11	TRANSFORMER, LINE FILTER (ALL EXCEPT KV-24FV12)	
T603	$\triangle$ 1-433-806-11	TRANSFORMER, REGULATOR (KV-24FV12 ONLY)	
T603	$\triangle$ 1-433-807-11	TRANSFORMER, REGULATOR (ALL EXCEPT KV-24FV12)	
T604	$\triangle$ 1-431-852-11	TRANSFORMER, CONVERTER (SRT)	

**THERMISTOR**

TH601	$\triangle$ 1-803-586-11	THERMISTOR, NTC
-------	--------------------------	-----------------

**THERMISTOR**

THP601	$\triangle$ 1-809-539-11	THERMISTOR, POSITIVE (KV-24FV12 ONLY)
THP601	$\triangle$ 1-803-540-11	THERMISTOR (ALL EXCEPT KV-24FV12)

**TUNER**

TU101	$\triangle$ 8-598-431-30	TUNER, FSS BTF-WA411
-------	--------------------------	----------------------

**VARISTOR**

VDR601	$\triangle$ 1-803-585-11	VARISTOR ENE271D-10A (KV-24FV12 ONLY)
VDR601	$\triangle$ 1-803-967-11	VARISTOR (ENE621D-14A) (ALL EXCEPT KV-24FV12)

CB
----

*	A-1332-057-A	CB (VAR) MOUNTED PC BOARD
	4-382-854-11	SCREW (M3X10), P, SW (+)

**CAPACITOR**

C701	1-104-664-11	ELECT	47 $\mu$ F	20%	25V
C702	1-136-165-00	MYLAR	0.1 $\mu$ F	5%	50V
C703	1-104-664-11	ELECT	47 $\mu$ F	20%	25V
C704	1-107-649-11	ELECT	2.2 $\mu$ F	20%	250V
C705	1-107-652-11	ELECT	10 $\mu$ F	20%	250V

**Note:**

The components identified by shading and mark  $\triangle$  are critical for safety. Replace only with part number specified.

**Note:**

Les composants identifiés par un trame et une marque  $\triangle$  sont critiques pour la sécurité. Ne les remplacer que par une pièce portant le numéro spécifié.

<b>CB</b>	<b>HZ</b>	<b>K</b>
-----------	-----------	----------

REF.NO.	PART NO.	DESCRIPTION	REMARK
C707	1-162-114-00	CERAMIC	0.0047 $\mu$ F 2KV
C708	1-136-165-00	MYLAR	0.1 $\mu$ F 5% 50V
C709	1-126-934-11	ELECT	220 $\mu$ F 20% 16V
C710	1-126-964-11	ELECT	10 $\mu$ F 20% 50V

**CONNECTOR**

CN701 *	1-564-506-11	PLUG, CONNECTOR 3P
CN702	1-695-915-11	TAB (CONTACT)
CN705	1-564-512-11	PLUG, CONNECTOR 9P
CN706 *	1-564-509-11	PLUG, CONNECTOR 6P

**DIODE**

D701	8-719-901-83	DIODE 1SS83TD
D702	8-719-901-83	DIODE 1SS83TD
D703	8-719-901-83	DIODE 1SS83TD
D704	8-719-302-43	DIODE RGP10GPKG23

**IC**

IC701	8-759-803-42	IC LA6500-FA
IC702	8-759-562-43	IC TDA6108JF/N1B

**JACK**

J701 $\triangle$	1-451-470-21	SOCKET, CRT
------------------	--------------	-------------

**COIL**

L701	1-408-613-31	INDUCTOR	68 $\mu$ H
------	--------------	----------	------------

**TRANSISTOR**

Q700	8-729-423-33	TRANSISTOR 2SC3311A-QRSTA
Q701	8-729-423-33	TRANSISTOR 2SC3311A-QRSTA

**RESISTOR**

R700	1-247-863-91	CARBON	22K	5%	1/4W
R701	1-249-429-11	CARBON	10K	5%	1/4W
R702	1-247-815-91	CARBON	220	5%	1/4W
R703	1-247-807-31	CARBON	100	5%	1/4W
R704	1-249-421-11	CARBON	2.2K	5%	1/4W
R705	1-249-429-11	CARBON	10K	5%	1/4W
R706	1-249-381-11	CARBON	1	5%	1/4W
R707	1-249-383-11	CARBON	1.5	5%	1/4W
R708	1-247-807-31	CARBON	100	5%	1/4W
R709	1-247-807-31	CARBON	100	5%	1/4W
R710	1-247-807-31	CARBON	100	5%	1/4W
R711	1-260-099-11	CARBON	1K	5%	1/2W

REF.NO.	PART NO.	DESCRIPTION	REMARK
R712	1-260-099-11	CARBON	1K 5% 1/2W
R713	1-260-099-11	CARBON	1K 5% 1/2W
R714	1-260-087-11	CARBON	100 5% 1/2W
R715	1-260-132-11	CARBON	560K 5% 1/2W

R716	1-260-123-11	CARBON	100K 5% 1/2W
R717	1-216-373-11	METAL OXIDE	2.2 5% 2W
R718	1-216-375-00	METAL OXIDE	3.3 5% 2W
R719	1-215-888-00	METAL OXIDE	220 5% 2W
R720	1-249-421-11	CARBON	2.2K 5% 1/4W
R721	1-249-421-11	CARBON	2.2K 5% 1/4W

**VARIABLE RESISTOR**

RV701	1-241-656-11	RES, ADJ, METAL FILM	110M
-------	--------------	----------------------	------

<b>HZ</b>
-----------

\* A-1372-117-A MOUNTED PWB, HZ  
(KV-25FV12A ONLY)

**CONNECTOR**

CN901 *	1-580-843-11	PIN, CONNECTOR (POWER)
CN902 *	1-580-843-11	PIN, CONNECTOR (POWER)

**SWITCH**

S901 $\triangle$	1-571-433-21	SWITCH, PUSH (AC POWER)
------------------	--------------	-------------------------

<b>K</b>
----------

\* A-1380-629-A K (VAR) MOUNTED PC BOARD

**CAPACITOR**

C201	1-126-963-11	ELECT	4.7 $\mu$ F	20%	50V
C202	1-126-963-11	ELECT	4.7 $\mu$ F	20%	50V
C404	1-164-182-11	CERAMIC CHIP	0.0033 $\mu$ F	10%	50V
C405	1-163-034-00	CERAMIC CHIP	0.033 $\mu$ F		50V
C406	1-163-011-11	CERAMIC CHIP	0.0015 $\mu$ F	10%	50V
C407	1-164-222-11	CERAMIC CHIP	0.22 $\mu$ F		25V
C408	1-164-222-11	CERAMIC CHIP	0.22 $\mu$ F		25V
C409	1-163-011-11	CERAMIC CHIP	0.0015 $\mu$ F	10%	50V
C410	1-163-034-00	CERAMIC CHIP	0.033 $\mu$ F		50V
C411	1-164-182-11	CERAMIC CHIP	0.0033 $\mu$ F	10%	50V
C412	1-163-038-91	CERAMIC CHIP	0.1 $\mu$ F		25V



## Note:

The components identified by shading and mark  $\triangle$  are critical for safety. Replace only with part number specified.

## Note:

Les composants identifiés par un trame et une marque  $\triangle$  sont critiques pour la sécurité. Ne les remplacer que par une pièce portant le numéro spécifié.



REF.NO.	PART NO.	DESCRIPTION	REMARK			REF.NO.	PART NO.	DESCRIPTION	REMARK		
C1014	1-130-495-00	MYLAR	0.1 $\mu$ F	5%	50V	C1315	1-163-021-91	CERAMIC CHIP	0.01 $\mu$ F	10%	50V
C1015	1-163-231-11	CERAMIC CHIP	15PF	5%	50V	C1320	1-163-021-91	CERAMIC CHIP	0.01 $\mu$ F	10%	50V
C1016	1-163-231-11	CERAMIC CHIP	15PF	5%	50V	C1321	1-163-021-91	CERAMIC CHIP	0.01 $\mu$ F	10%	50V
C1018	1-126-960-11	ELECT	1 $\mu$ F	20%	50V	C1322	1-163-021-91	CERAMIC CHIP	0.01 $\mu$ F	10%	50V
C1019	1-104-664-11	ELECT	47 $\mu$ F	20%	25V	C1323	1-126-933-11	ELECT	100 $\mu$ F	20%	16V
C1020	1-163-013-91	CERAMIC CHIP	2200PF	10%	50V	C1324	1-163-021-91	CERAMIC CHIP	0.01 $\mu$ F	10%	50V
C1021	1-163-259-91	CERAMIC CHIP	220PF	5%	50V	C1325	1-163-123-00	CERAMIC CHIP	180PF	5%	50V
C1022	1-163-135-00	CERAMIC CHIP	560PF	5%	50V	C1326	1-163-021-91	CERAMIC CHIP	0.01 $\mu$ F	10%	50V
C1023	1-163-009-11	CERAMIC CHIP	0.001 $\mu$ F	10%	50V	C1327	1-126-933-11	ELECT	100 $\mu$ F	20%	16V
C1024	1-163-259-91	CERAMIC CHIP	220PF	5%	50V	C1328	1-163-227-11	CERAMIC CHIP	10PF	0.50PF	50V
C1026	1-163-259-91	CERAMIC CHIP	220PF	5%	50V	C1329	1-163-010-11	CERAMIC CHIP	0.0012 $\mu$ F	10%	50V
C1027	1-163-038-91	CERAMIC CHIP	0.1 $\mu$ F		25V	C1330	1-163-231-11	CERAMIC CHIP	15PF	5%	50V
C1028	1-163-259-91	CERAMIC CHIP	220PF	5%	50V	C1331	1-163-021-91	CERAMIC CHIP	0.01 $\mu$ F	10%	50V
C1029	1-163-013-91	CERAMIC CHIP	2200PF	10%	50V	C1332	1-163-021-91	CERAMIC CHIP	0.01 $\mu$ F	10%	50V
C1031	1-163-009-11	CERAMIC CHIP	0.001 $\mu$ F	10%	50V	C1334	1-163-021-91	CERAMIC CHIP	0.01 $\mu$ F	10%	50V
C1032	1-163-267-91	CERAMIC CHIP	470PF	5%	50V	C1335	1-163-021-91	CERAMIC CHIP	0.01 $\mu$ F	10%	50V
C1034	1-163-259-91	CERAMIC CHIP	220PF	5%	50V	C1336	1-163-021-91	CERAMIC CHIP	0.01 $\mu$ F	10%	50V
C1035	1-163-267-91	CERAMIC CHIP	470PF	5%	50V	C1339	1-163-021-91	CERAMIC CHIP	0.01 $\mu$ F	10%	50V
C1041	1-126-935-11	ELECT	470 $\mu$ F	20%	16V	C1340	1-126-963-11	ELECT	4.7 $\mu$ F	20%	50V
C1042	1-163-013-91	CERAMIC CHIP	2200PF	10%	50V	C1341	1-163-021-91	CERAMIC CHIP	0.01 $\mu$ F	10%	50V
C1043	1-163-809-91	CERAMIC CHIP	0.047 $\mu$ F	10%	25V	C1342	1-163-021-91	CERAMIC CHIP	0.01 $\mu$ F	10%	50V
C1048	1-137-194-81	MYLAR	0.47 $\mu$ F	5%	50V	C1343	1-163-038-91	CERAMIC CHIP	0.1 $\mu$ F		25V
C1049	1-163-017-00	CERAMIC CHIP	0.0047 $\mu$ F	10%	50V	C1344	1-126-935-11	ELECT	470 $\mu$ F	20%	16V
C1050	1-163-037-11	CERAMIC CHIP	0.022 $\mu$ F	10%	50V	C1345	1-163-021-91	CERAMIC CHIP	0.01 $\mu$ F	10%	50V
C1053	1-163-229-11	CERAMIC CHIP	12PF	5%	50V	C1349	1-163-021-91	CERAMIC CHIP	0.01 $\mu$ F	10%	50V
C1054	1-163-259-91	CERAMIC CHIP	220PF	5%	50V	C1350	1-163-021-91	CERAMIC CHIP	0.01 $\mu$ F	10%	50V
C1055	1-163-229-11	CERAMIC CHIP	12PF	5%	50V	C1351	1-126-963-11	ELECT	4.7 $\mu$ F	20%	50V
C1056	1-163-009-11	CERAMIC CHIP	0.001 $\mu$ F	10%	50V	C1352	1-104-664-11	ELECT	47 $\mu$ F	20%	25V
C1058	1-163-009-11	CERAMIC CHIP	0.001 $\mu$ F	10%	50V	C1353	1-126-964-11	ELECT	10 $\mu$ F	20%	50V
C1060	1-163-009-11	CERAMIC CHIP	0.001 $\mu$ F	10%	50V	C1354	1-126-959-11	ELECT	0.47 $\mu$ F	20%	50V
C1066	1-163-009-11	CERAMIC CHIP	0.001 $\mu$ F	10%	50V	(ALL EXCEPT KV-25FV12A)					
C1068	1-163-009-11	CERAMIC CHIP	0.001 $\mu$ F	10%	50V	C1354	1-126-957-11	ELECT	0.22UF	20%	50V
C1071	1-163-009-11	CERAMIC CHIP	0.001 $\mu$ F	10%	50V	(KV-25FV12A ONLY)					
C1072	1-163-259-91	CERAMIC CHIP	220PF	5%	50V	C1355	1-126-767-11	ELECT	1000 $\mu$ F	20%	16V
C1073	1-163-259-91	CERAMIC CHIP	220PF	5%	50V	C1356	1-163-259-91	CERAMIC CHIP	220PF	5%	50V
C1074	1-163-259-91	CERAMIC CHIP	220PF	5%	50V	(KV-25FV12A ONLY)					
C1075	1-126-935-11	ELECT	470 $\mu$ F	20%	16V	C1356	1-163-133-00	CERAMIC CHIP	470PF	5%	50V
C1076	1-126-959-11	ELECT	0.47 $\mu$ F	20%	50V	(ALL EXCEPT KV-25FV12A)					
C1077	1-126-964-11	ELECT	10 $\mu$ F	20%	50V	C1357	1-163-038-91	CERAMIC CHIP	0.1 $\mu$ F		25V
C1099	1-163-009-11	CERAMIC CHIP	0.001 $\mu$ F	10%	50V	C1358	1-126-963-11	ELECT	4.7 $\mu$ F	20%	50V
C1304	1-126-959-11	ELECT	0.47 $\mu$ F	20%	50V	C1359	1-126-964-11	ELECT	10 $\mu$ F	20%	50V
C1305	1-163-021-91	CERAMIC CHIP	0.01 $\mu$ F	10%	50V	C1361	1-163-231-11	CERAMIC CHIP	15PF	5%	50V
C1306	1-126-933-11	ELECT	100 $\mu$ F	20%	16V	C1363	1-163-233-11	CERAMIC CHIP	18PF	5%	50V
C1307	1-163-021-91	CERAMIC CHIP	0.01 $\mu$ F	10%	50V	(KV-25FV12A ONLY)					
C1308	1-126-933-11	ELECT	100 $\mu$ F	20%	16V	C1364	1-163-233-11	CERAMIC CHIP	18PF	5%	50V
C1309	1-163-021-91	CERAMIC CHIP	0.01 $\mu$ F	10%	50V	(KV-25FV12A ONLY)					
C1310	1-163-021-91	CERAMIC CHIP	0.01 $\mu$ F	10%	50V	C1365	1-163-233-11	CERAMIC CHIP	18PF	5%	50V
C1311	1-163-038-91	CERAMIC CHIP	0.1 $\mu$ F		25V	(KV-25FV12A ONLY)					
C1313	1-163-021-91	CERAMIC CHIP	0.01 $\mu$ F	10%	50V	C1366	1-126-964-11	ELECT	10 $\mu$ F	20%	50V
						C1367	1-126-964-11	ELECT	10 $\mu$ F	20%	50V
						C1375	1-163-034-00	CERAMIC CHIP	0.033 $\mu$ F		50V



## Note:

The components identified by shading and mark  $\triangle$  are critical for safety. Replace only with part number specified.

## Note:

Les composants identifiés par un trame et une marque  $\triangle$  sont critiques pour la sécurité. Ne les remplacer que par une pièce portant le numéro spécifié.

MB

REF.NO.	PART NO.	DESCRIPTION	REMARK	REF.NO.	PART NO.	DESCRIPTION	REMARK
<b>TRANSISTOR</b>							
Q1001	8-729-216-22	TRANSISTOR 2SB709A-QRS-TX		R1029	1-216-113-00	RES-CHIP	470K 5% 1/10W
Q1002	8-729-216-22	TRANSISTOR 2SB709A-QRS-TX		R1030	1-216-049-91	RES-CHIP	1K 5% 1/10W
Q1003	8-729-422-27	TRANSISTOR 2SD601A-QRS-TX		R1031	1-216-041-00	RES-CHIP	470 5% 1/10W
Q1009	8-729-216-22	TRANSISTOR 2SB709A-QRS-TX		R1032	1-216-065-91	RES-CHIP	4.7K 5% 1/10W
Q1010	8-729-422-27	TRANSISTOR 2SD601A-QRS-TX		R1033	1-216-081-00	RES-CHIP	22K 5% 1/10W
Q1011	8-729-422-27	TRANSISTOR 2SD601A-QRS-TX		R1034	1-216-043-91	RES-CHIP	560 5% 1/10W
Q1301	8-729-422-27	TRANSISTOR 2SD601A-QRS-TX		R1035	1-216-049-91	RES-CHIP	1K 5% 1/10W
Q1302	8-729-216-22	TRANSISTOR 2SB709A-QRS-TX		R1036	1-216-033-00	RES-CHIP	220 5% 1/10W
Q1306	8-729-422-27	TRANSISTOR 2SD601A-QRS-TX		R1037	1-216-033-00	RES-CHIP	220 5% 1/10W
Q1307	8-729-216-22	TRANSISTOR 2SB709A-QRS-TX		R1038	1-216-025-91	RES-CHIP	100 5% 1/10W
Q1308	8-729-216-22	TRANSISTOR 2SB709A-QRS-TX		R1040	1-216-033-00	RES-CHIP	220 5% 1/10W
Q1310	8-729-422-27	TRANSISTOR 2SD601A-QRS-TX		R1041	1-216-073-00	RES-CHIP	10K 5% 1/10W
Q1311	8-729-422-27	TRANSISTOR 2SD601A-QRS-TX		R1042	1-249-413-11	CARBON	470 5% 1/4W
Q1312	8-729-216-22	TRANSISTOR 2SB709A-QRS-TX		R1043	1-216-071-00	RES-CHIP	8.2K 5% 1/10W
Q1313	8-729-216-22	TRANSISTOR 2SB709A-QRS-TX		R1044	1-216-065-91	RES-CHIP	4.7K 5% 1/10W
Q1315	8-729-216-22	TRANSISTOR 2SB709A-QRS-TX		R1045	1-216-065-91	RES-CHIP	4.7K 5% 1/10W
Q1316	8-729-216-22	TRANSISTOR 2SB709A-QRS-TX		R1046	1-249-425-11	CARBON	4.7K 5% 1/4W
Q1317	8-729-216-22	TRANSISTOR 2SB709A-QRS-TX		R1047	1-216-065-91	RES-CHIP	4.7K 5% 1/10W
Q1325	8-729-422-27	TRANSISTOR 2SD601A-QRS-TX		R1048	1-216-065-91	RES-CHIP	4.7K 5% 1/10W
Q1326	8-729-422-27	TRANSISTOR 2SD601A-QRS-TX		R1049	1-216-065-91	RES-CHIP	4.7K 5% 1/10W
Q1327	8-729-422-27	TRANSISTOR 2SD601A-QRS-TX		R1050	1-216-065-91	RES-CHIP	4.7K 5% 1/10W
Q1328	8-729-216-22	TRANSISTOR 2SB709A-QRS-TX		R1052	1-216-033-00	RES-CHIP	220 5% 1/10W
Q1329	8-729-216-22	TRANSISTOR 2SB709A-QRS-TX		R1053	1-216-033-00	RES-CHIP	220 5% 1/10W
Q1330	8-729-120-28	TRANSISTOR 2SC2412K-T-146-QR (KV-25FV12A ONLY)		R1054	1-216-065-91	RES-CHIP	4.7K 5% 1/10W
Q1330	8-729-422-27	TRANSISTOR 2SD601A-QRS-TX (ALL EXCEPT KV-25FV12A)		R1055	1-216-049-91	RES-CHIP	1K 5% 1/10W
Q1331	8-729-216-22	TRANSISTOR 2SB709A-QRS-TX		R1056	1-216-081-00	RES-CHIP	22K 5% 1/10W
Q1332	8-729-216-22	TRANSISTOR 2SB709A-QRS-TX		R1057	1-216-049-91	RES-CHIP	1K 5% 1/10W
Q1336	8-729-422-27	TRANSISTOR 2SD601A-QRS-TX		R1058	1-216-635-11	METAL CHIP	220 1% 1/10W
Q1350	8-729-216-22	TRANSISTOR 2SB709A-QRS-TX		R1059	1-247-815-91	CARBON	220 5% 1/4W
Q1354	8-729-216-22	TRANSISTOR 2SB709A-QRS-TX		R1060	1-216-635-11	METAL CHIP	220 1% 1/10W
<b>RESISTOR</b>							
R1001	1-216-065-91	RES-CHIP	4.7K 5% 1/10W	R1066	1-216-033-00	RES-CHIP	220 5% 1/10W
R1016	1-216-049-91	RES-CHIP	1K 5% 1/10W	R1067	1-216-033-00	RES-CHIP	220 5% 1/10W
R1017	1-216-025-91	RES-CHIP	100 5% 1/10W	R1068	1-216-025-91	RES-CHIP	100 5% 1/10W
R1018	1-249-429-11	CARBON	10K 5% 1/4W	R1069	1-216-033-00	RES-CHIP	220 5% 1/10W
R1019	1-216-045-00	RES-CHIP	680 5% 1/10W	R1070	1-216-033-00	RES-CHIP	220 5% 1/10W
R1020	1-216-097-91	RES-CHIP	100K 5% 1/10W	R1071	1-208-806-11	METAL CHIP	10K 1% 1/10W
R1021	1-216-121-91	RES-CHIP	1M 5% 1/10W	R1072	1-216-065-91	RES-CHIP	4.7K 5% 1/10W
R1022	1-216-073-00	RES-CHIP	10K 5% 1/10W	R1073	1-216-065-91	RES-CHIP	4.7K 5% 1/10W
R1023	1-216-073-00	RES-CHIP	10K 5% 1/10W	R1074	1-216-355-11	METAL OXIDE	3.3 5% 1W
R1024	1-216-033-00	RES-CHIP	220 5% 1/10W	R1075	1-216-065-91	RES-CHIP	4.7K 5% 1/10W
R1025	1-208-814-91	METAL CHIP	22K 1% 1/10W	R1076	1-216-065-91	RES-CHIP	4.7K 5% 1/10W
R1026	1-216-065-91	RES-CHIP	4.7K 5% 1/10W	R1077	1-216-065-91	RES-CHIP	4.7K 5% 1/10W
R1027	1-216-041-00	RES-CHIP	470 5% 1/10W	R1078	1-216-049-91	RES-CHIP	1K 5% 1/10W
R1028	1-216-045-00	RES-CHIP	680 5% 1/10W	R1079	1-216-069-00	RES-CHIP	6.8K 5% 1/10W

**MB****Note:**

The components identified by shading and mark  $\triangle$  are critical for safety. Replace only with part number specified.

**Note:**

Les composants identifiés par un trame et une marque  $\triangle$  sont critiques pour la sécurité. Ne les remplacer que par une pièce portant le numéro spécifié.

REF.NO.	PART NO.	DESCRIPTION	REMARK	REF.NO.	PART NO.	DESCRIPTION	REMARK
R1080	1-216-069-00	RES-CHIP	6.8K 5% 1/10W	R1338	1-216-091-00	RES-CHIP	56K 5% 1/10W
R1081	1-216-069-00	RES-CHIP	6.8K 5% 1/10W	R1342	1-216-025-91	RES-CHIP	100 5% 1/10W
R1082	1-216-065-91	RES-CHIP	4.7K 5% 1/10W	R1344	1-216-025-91	RES-CHIP	100 5% 1/10W
R1084	1-216-045-00	RES-CHIP	680 5% 1/10W	R1345	1-216-049-91	RES-CHIP	1K 5% 1/10W
R1085	1-216-045-00	RES-CHIP	680 5% 1/10W	R1346	1-216-033-00	RES-CHIP	220 5% 1/10W
R1086	1-216-045-00	RES-CHIP	680 5% 1/10W	R1347	1-216-025-91	RES-CHIP	100 5% 1/10W
R1087	1-216-061-00	RES-CHIP	3.3K 5% 1/10W	R1348	1-216-025-91	RES-CHIP	100 5% 1/10W
R1090	1-216-033-00	RES-CHIP	220 5% 1/10W	R1349	1-216-295-91	SHORT	
R1098	1-216-033-00	RES-CHIP	220 5% 1/10W			(KV-25FV12A ONLY)	
R1099	1-208-798-11	METAL CHIP	4.7K 1% 1/10W	R1350	1-216-073-00	RES-CHIP	10K 5% 1/10W
R1103	1-216-065-91	RES-CHIP	4.7K 5% 1/10W	R1351	1-216-067-00	RES-CHIP	5.6K 5% 1/10W
R1104	1-216-073-00	RES-CHIP	10K 5% 1/10W	R1352	1-216-049-91	RES-CHIP	1K 5% 1/10W
R1105	1-216-073-00	RES-CHIP	10K 5% 1/10W	R1355	1-216-025-91	RES-CHIP	100 5% 1/10W
R1108	1-216-065-91	RES-CHIP	4.7K 5% 1/10W	R1356	1-216-067-00	RES-CHIP	5.6K 5% 1/10W
R1109	1-216-073-00	RES-CHIP	10K 5% 1/10W	R1357	1-216-043-91	RES-CHIP	560 5% 1/10W
R1110	1-216-059-00	RES-CHIP	2.7K 5% 1/10W	R1358	1-216-057-00	RES-CHIP	2.2K 5% 1/10W
R1111	1-216-065-91	RES-CHIP	4.7K 5% 1/10W	R1359	1-216-025-91	RES-CHIP	100 5% 1/10W
R1300	1-216-049-91	RES-CHIP	1K 5% 1/10W	R1360	1-216-041-00	RES-CHIP	470 5% 1/10W
R1301	1-216-053-00	RES-CHIP	1.5K 5% 1/10W	R1361	1-216-295-91	SHORT	
R1302	1-216-041-00	RES-CHIP	470 5% 1/10W	R1362	1-216-065-91	RES-CHIP	4.7K 5% 1/10W
R1303	1-216-025-91	RES-CHIP	100 5% 1/10W	R1363	1-216-043-91	RES-CHIP	560 5% 1/10W
R1304	1-216-049-91	RES-CHIP	1K 5% 1/10W	R1364	1-216-025-91	RES-CHIP	100 5% 1/10W
R1306	1-216-033-00	RES-CHIP	220 5% 1/10W	R1365	1-216-025-91	RES-CHIP	100 5% 1/10W
R1308	1-216-033-00	RES-CHIP	220 5% 1/10W	R1366	1-216-025-91	RES-CHIP	100 5% 1/10W
R1310	1-216-025-91	RES-CHIP	100 5% 1/10W	R1367	1-216-025-91	RES-CHIP	100 5% 1/10W
R1311	1-216-047-91	RES-CHIP	820 5% 1/10W	R1368	1-216-073-00	RES-CHIP	10K 5% 1/10W
R1312	1-208-806-11	METAL CHIP	10K 1% 1/10W	R1369	1-259-884-11	CARBON	4.7M 5% 1/4W
R1313	1-216-033-00	RES-CHIP	220 5% 1/10W			(KV-25FV12A ONLY)	
R1314	1-216-022-00	RES-CHIP	75 5% 1/10W	R1371	1-216-295-91	SHORT	
R1315	1-216-053-00	RES-CHIP	1.5K 5% 1/10W			(KV-25FV12A ONLY)	
R1316	1-216-295-91	SHORT		R1372	1-216-295-91	SHORT	
R1317	1-216-022-00	RES-CHIP	75 5% 1/10W	R1373	1-216-295-91	SHORT	
R1318	1-216-022-00	RES-CHIP	75 5% 1/10W			(KV-25FV12A ONLY)	
R1319	1-216-022-00	RES-CHIP	75 5% 1/10W	R1374	1-216-049-91	RES-CHIP	1K 5% 1/10W
R1320	1-216-025-91	RES-CHIP	100 5% 1/10W	R1375	1-216-295-91	SHORT	
R1322	1-216-081-00	RES-CHIP	22K 5% 1/10W	R1376	1-216-295-91	SHORT	
R1323	1-216-025-91	RES-CHIP	100 5% 1/10W	R1378	1-216-295-91	SHORT	
R1325	1-216-057-00	RES-CHIP	2.2K 5% 1/10W	R1379	1-216-057-00	RES-CHIP	2.2K 5% 1/10W
R1326	1-216-043-91	RES-CHIP	560 5% 1/10W	R1380	1-216-057-00	RES-CHIP	2.2K 5% 1/10W
R1327	1-216-025-91	RES-CHIP	100 5% 1/10W	R1381	1-216-057-00	RES-CHIP	2.2K 5% 1/10W
R1328	1-216-067-00	RES-CHIP	5.6K 5% 1/10W	R1382	1-216-097-91	RES-CHIP	100K 5% 1/10W
R1329	1-216-091-00	RES-CHIP	56K 5% 1/10W	R1383	1-216-097-91	RES-CHIP	100K 5% 1/10W
R1330	1-216-081-00	RES-CHIP	22K 5% 1/10W	R1384	1-216-097-91	RES-CHIP	100K 5% 1/10W
R1331	1-216-049-91	RES-CHIP	1K 5% 1/10W	R1385	1-216-085-00	RES-CHIP	33K 5% 1/10W
R1332	1-216-043-91	RES-CHIP	560 5% 1/10W	R1386	1-216-073-00	RES-CHIP	10K 5% 1/10W
R1333	1-216-033-00	RES-CHIP	220 5% 1/10W	R1387	1-216-085-00	RES-CHIP	33K 5% 1/10W
R1334	1-216-025-91	RES-CHIP	100 5% 1/10W	R1388	1-216-129-00	RES-CHIP	2.2M 5% 1/10W
R1335	1-216-025-91	RES-CHIP	100 5% 1/10W	R1389	1-216-071-00	RES-CHIP	8.2K 5% 1/10W
R1336	1-216-053-00	RES-CHIP	1.5K 5% 1/10W	R1390	1-216-025-91	RES-CHIP	100 5% 1/10W
				R1391	1-216-073-00	RES-CHIP	10K 5% 1/10W

**Note:**

The components identified by shading and mark  $\triangle$  are critical for safety. Replace only with part number specified.

**Note:**

Les composants identifiés par un trame et une marque  $\triangle$  sont critiques pour la sécurité. Ne les remplacer que par une pièce portant le numéro spécifié.

MB	VB
----	----

REF.NO.	PART NO.	DESCRIPTION	REMARK	REF.NO.	PART NO.	DESCRIPTION	REMARK
R1392	1-216-295-91	SHORT		C905	1-106-383-00	MYLAR	0.047 $\mu$ F 10% 200V
R1393	1-216-069-00	RES-CHIP	6.8K 5% 1/10W	C906	1-130-471-00	MYLAR	0.001 $\mu$ F 5% 50V
R1394	1-216-033-00	RES-CHIP	220 5% 1/10W	C907	1-107-638-11	ELECT	33 $\mu$ F 20% 160V
R1395	1-216-033-00	RES-CHIP	220 5% 1/10W	C908	1-126-925-11	ELECT	470 $\mu$ F 20% 10V
R1396	1-216-033-00	RES-CHIP	220 5% 1/10W	C909	1-161-830-00	CERAMIC	0.0047 $\mu$ F 500V
R1397	1-216-033-00	RES-CHIP	220 5% 1/10W	C910	1-104-999-11	MYLAR	0.1 $\mu$ F 10% 200V
R1398	1-216-049-91	RES-CHIP	1K 5% 1/10W	C911	1-104-665-11	ELECT	100 $\mu$ F 20% 10V
R1399	1-216-073-00	RES-CHIP	10K 5% 1/10W	C912	1-126-941-11	ELECT	470 $\mu$ F 20% 25V
R1400	1-216-295-91	SHORT		C913	1-102-074-00	CERAMIC	0.001 $\mu$ F 10% 50V
R1401	1-216-073-00	RES-CHIP	10K 5% 1/10W	C914	1-130-491-00	MYLAR	0.047 $\mu$ F 5% 50V
R1402	1-216-065-91	RES-CHIP	4.7K 5% 1/10W	<b>CONNECTOR</b>			
R1403	1-216-049-91	RES-CHIP	1K 5% 1/10W	CN901 *	1-564-508-11	PLUG, CONNECTOR 5P	
R1404	1-216-073-00	RES-CHIP	10K 5% 1/10W	CN902 *	1-770-723-11	CONNECTOR, BOARD TO BOARD 8P	
R1406	1-216-049-91	RES-CHIP	1K 5% 1/10W	<b>DIODE</b>			
R1407	1-216-065-91	RES-CHIP	4.7K 5% 1/10W	D901	8-719-110-88	DIODE MTZJ-T-77-39	
R1409	1-216-043-91	RES-CHIP	560 5% 1/10W	D902	8-719-110-88	DIODE MTZJ-T-77-39	
R1410	1-216-295-91	SHORT		D903	8-719-991-33	DIODE 1SS133T-77	
		(ALL EXCEPT KV-25FV12A)		<b>TRANSISTOR</b>			
R1411	1-216-033-00	RES-CHIP	220 5% 1/10W	Q901	8-729-017-06	TRANSISTOR 2SC4793	
R1412	1-216-635-11	METAL CHIP	220 1% 1/10W	Q902	8-729-017-05	TRANSISTOR 2SA1837	
R1413	1-216-091-00	RES-CHIP	56K 5% 1/10W	Q903	8-729-423-33	TRANSISTOR 2SC3311A-QRSTA	
R1414	1-216-049-91	RES-CHIP	1K 5% 1/10W	Q904	8-729-423-33	TRANSISTOR 2SC3311A-QRSTA	
R1415	1-216-049-91	RES-CHIP	1K 5% 1/10W	Q905	8-729-119-76	TRANSISTOR 2SA1309A-QRSTA	
R1416	1-216-057-00	RES-CHIP	2.2K 5% 1/10W	Q906	8-729-423-33	TRANSISTOR 2SC3311A-QRSTA	
R1417	1-216-035-00	RES-CHIP	270 5% 1/10W	<b>RESISTOR</b>			
R1418	1-216-045-00	RES-CHIP	680 5% 1/10W	R901	1-249-401-11	CARBON	47 5% 1/4W
R1419	1-216-295-91	SHORT		R902	1-249-386-11	CARBON	2.7 5% 1/4W
R1442	1-216-111-00	RES-CHIP	390K 5% 1/10W	R903	1-249-414-11	CARBON	560 5% 1/4W
<b>CRYSTAL</b>				R904	1-249-432-11	CARBON	18K 5% 1/4W
X1001	1-767-487-11	VIBRATOR, CRYSTAL		R905	1-249-417-11	CARBON	1K 5% 1/4W
X1303	1-579-973-11	VIBRATOR, CRYSTAL (KV-25FV12A ONLY)		R906	1-249-432-11	CARBON	18K 5% 1/4W
X1304	1-567-505-11	OSCILLATOR, CRYSTAL		R907	1-249-386-11	CARBON	2.7 5% 1/4W
X1305	1-579-972-11	VIBRATOR, CRYSTAL (KV-25FV12A ONLY)		R908	1-249-414-11	CARBON	560 5% 1/4W
<b>CAPACITOR</b>				R909	1-260-312-11	CARBON	47 5% 1/2W
C901	1-107-667-11	ELECT	2.2 $\mu$ F 20% 160V	R910	1-216-476-11	METAL OXIDE	180 5% 3W
C902	1-130-491-00	MYLAR	0.047 $\mu$ F 5% 50V	R911	1-249-403-11	CARBON	68 5% 1/4W
C903	1-126-925-11	ELECT	470 $\mu$ F 20% 10V	R912	1-247-815-91	CARBON	220 5% 1/4W
C904	1-130-471-00	MYLAR	0.001 $\mu$ F 5% 50V	R913	1-249-403-11	CARBON	68 5% 1/4W
				R914	1-249-410-11	CARBON	270 5% 1/4W
				R915	1-249-417-11	CARBON	1K 5% 1/4W
				R916	1-249-417-11	CARBON	1K 5% 1/4W
				R917	1-249-417-11	CARBON	1K 5% 1/4W

VB
----

\* A-1342-547-A VB (VAR) MOUNTED PC BOARD

4-382-854-11 SCREW (M3X10), P, SW (+)

**CAPACITOR**

C901	1-107-667-11	ELECT	2.2 $\mu$ F	20%	160V
C902	1-130-491-00	MYLAR	0.047 $\mu$ F	5%	50V
C903	1-126-925-11	ELECT	470 $\mu$ F	20%	10V
C904	1-130-471-00	MYLAR	0.001 $\mu$ F	5%	50V

VB

**Note:**

The components identified by shading and mark are critical for safety. Replace only with part number specified.

**Note:**

Les composants identifiés par un trame et une marque sont critiques pour la sécurité. Ne les remplacer que par une pièce portant le numéro spécifié.

<u>REF.NO.</u>	<u>PART.NO.</u>	<u>DESCRIPTION</u>	<u>REMARK</u>		
R918	1-247-807-31	CARBON	100	5%	1/4W
R919	1-247-807-31	CARBON	100	5%	1/4W
R920	1-249-416-11	CARBON	820	5%	1/4W
R921	1-249-429-11	CARBON	10K	5%	1/4W
R922	1-249-397-11	CARBON	22	5%	1/4W
R923	1-249-401-11	CARBON	47	5%	1/4W

**ACCESSORIES AND PACKAGING**

- 1-501-730-41 ANTENNA, TELESCOPIC  
(ALL EXCEPT KV-24FV12)
- \* 4-041-255-01 BAG, PROTECTION
- \* 4-067-891-02 CARTON, INDIVIDUAL  
(KV-24FV12 ONLY)
- \* 4-067-890-02 CARTON, INDIVIDUAL  
(ALL EXCEPT KV-24FV12)
- 1-417-182-11 CONVERTER (EAC-25)  
(ALL EXCEPT KV-24FV12)
- \* 4-067-892-03 CUSHION ASSY, UPPER
- \* 4-067-893-03 CUSHION ASSY, LOWER
- 4-075-501-21 MANUAL, INSTRUCTION  
(KV-24FV12 ONLY)
- 4-075-501-41 MANUAL, INSTRUCTION  
(ALL EXCEPT KV-24FV12)

**REMOTE COMMANDER**

- 1-418-387-11 REMOTE COMMANDER (RM-Y168)
- 4-978-977-01 BATTERY COVER FOR RM-Y168



