

TOSHIBA

Color Television

OWNER'S MANUAL

CF27F50



SET UP

PREPARATION

BASIC OPERATION

ADVANCED
OPERATION

EQUIPMENT
CONNECTIONS

REFERENCE
SECTION

Dear Customer

Congratulations! You have purchased one of the finest Color TV's on the market!

This manual will help you use the many exciting and useful features to make your TV viewing more enjoyable than ever before.

Before operating your TV set, please read all these safety and operating instructions completely and then retain for future reference.

Customer's Record

You will find the model number and serial number on the back of your TV set.

Record these numbers in the spaces provided below. Refer to them whenever you call upon your TOSHIBA dealer regarding this product.

Model Number _____

Serial Number _____

Safety Precautions

WARNING:

TO REDUCE THE RISK OF FIRE OR ELECTRIC SHOCK, DO NOT EXPOSE THIS APPLIANCE TO RAIN OR MOISTURE.

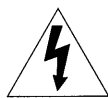
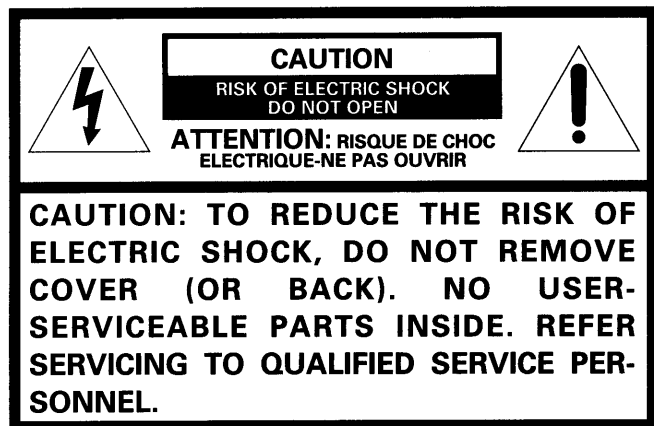

The lightning symbol in the triangle tells you that the voltage inside this product may be strong enough to cause an electric shock. **DO NOT TRY TO SERVICE THIS PRODUCT YOURSELF.**



The exclamation point in the triangle tells you that important operating and maintenance instructions follow this symbol.

This TV set may be used only with TOSHIBA stand model ST2712. Use with other stands may result in instability causing possible injury.

CAUTIONS:

TO PREVENT ELECTRIC SHOCK, DO NOT USE THIS POLARIZED PLUG WITH AN EXTENSION CORD RECEPTACLE OR OTHER OUTLET UNLESS THE PRONGS CAN BE FULLY INSERTED INTO THE OUTLET TO PREVENT ANY EXPOSURE OF THE PRONGS ON THE POLARIZED PLUG.

ATTENTION:

POUR PRÉVENIR LES CHOCS ÉLECTRIQUES, NE PAS UTILISER CETTE FICHE POLARISÉE AVEC UN PROLONGATEUR, UNE PRISE DE COURANT OU UNE AUTRE SORTIE DE COURANT, SAUF SI LES LAMES PEUVENT ÊTRE INSÉRÉS À FOND SANS EN LAISSER AUCUNE PARTIE À DÉCOUVERT.

Avoid displaying stationary images on your TV screen for extended periods of time. Stationary patterns generated by PIP display, computer displays, video games, stock market reports, etc. can become permanently engrained on the picture tube. This damage is not protected by your warranty as it is the result of misuse. Should you wish to use your TOSHIBA Television to display still images, it is always advisable to reduce brightness and contrast settings. Never leave a PIP display, computer display or video game display unattended.

NOTE TO CATV SYSTEM INSTALLER IN THE USA:

This reminder is provided to call the CATV system installer's attention to Article 820-40 of the NEC that provides guidelines for proper grounding and, in particular, specifies that the cable ground shall be connected to the grounding system of the building, as close to the point of cable entry as practical.

Table of Contents

Set Up

Installing Your TV Set	3
Antenna/Cable TV Connection	4

Preparation

Location of Controls (TV Set)	5
Location of Controls (Remote Control)	6
Before Using the Remote Control	7
Using the Remote with VCR or Cable TV	
Converter	8
Programming the Remote Control	9
Menu Function (General Instructions)	12
Programming Channel Memory	13

Basic Operation

Watching TV Programs	15
Convenient Remote Functions	16
Selecting Stereo/SAP Broadcasts	18

Advanced Operation

Adjusting the Picture	20
Adjusting the Sound	21
Watching Picture-in-Picture	22
Using Closed-Captioned Function	24
Locking Channels	26
Programming Your Favorite Channels	28
Changing On-Screen Display Language	29
Demonstration Mode	29

Equipment Connections

Connecting a VCR	30
Connecting an Audio Amplifier	31

Reference Section

Cleaning and Care	32
Specifications	32
Before Calling Service Personnel	33
Limited United States Warranty	34

Installing Your TV Set

Where to install

Place the TV on the floor or on a sturdy platform. The mounting surface should be flat and steady.

Lighting

Do not place the TV in a room where direct lighting strikes the screen. Use soft and indirect lighting.

Air circulation

Place the TV far enough from the walls to allow proper ventilation. This will prevent the TV from overheating and avoid possible damage to the TV. Avoid dusty places too.

Power supply

Plug into an electrical outlet with standard household power (120 volt AC, 60Hz). Do not change the plug's safety prong. See the right column.

WARNING : TO AVOID PERSONAL INJURY

- Do not stand or climb on the TV.
- Do not put a VCR or any heavy object on top of the TV.

CAUTION :

As a safety feature, the plug has one prong wider than the other. It will fit only one way into a standard electrical outlet. If the plug will not fit into the outlet, try turning it around. If the plug will not fit either way, the outlet is probably old and non-standard.

You will need to have a new outlet installed by an electrician.

DO NOT CHANGE THE SAFETY FEATURE OF THE PLUG.

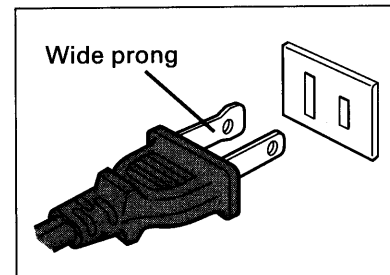

Antenna/Cable TV Connection

You can use either an indoor or outdoor antenna to receive VHF and/or UHF channels. Channels 2 - 13 are VHF channels, and channels 14 - 69 are UHF channels. We recommend using an outdoor antenna for better picture quality. You can receive Cable TV by connecting a cable supplied by your local cable company.

Connecting an antenna or Cable without a decoder box

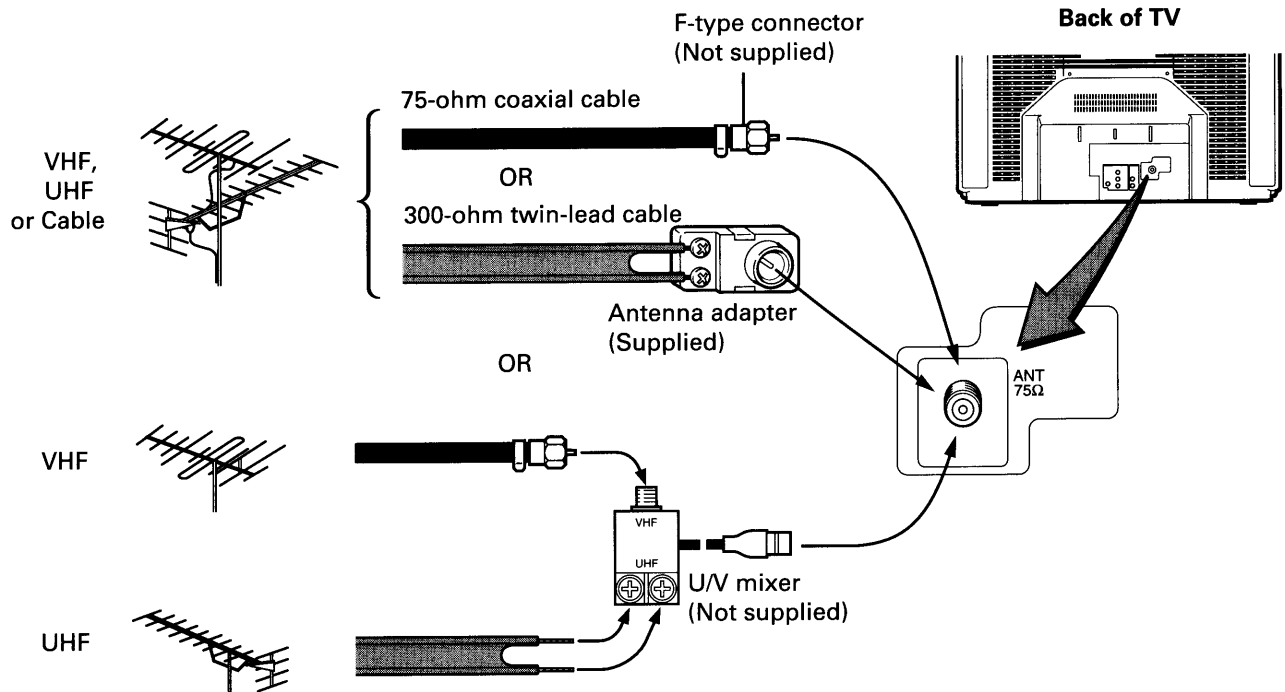

Connecting a Cable with a decoder box

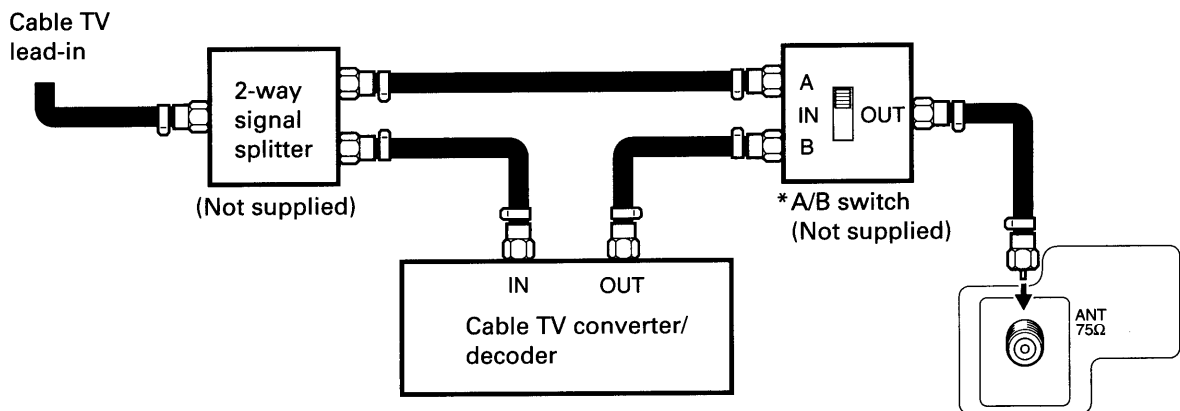

Notes:

- * "A" position on the A/B switch allows you to select unscrambled channels using the TV's channel keys.
- "B" position allows you to select scrambled channels via the converter/decoder box using the converter's channel keys. Place your TV on channel 3 or 4 to match the converter's output channel.
- If you use a VCR, connect its antenna in/out between the decoder box and A/B switch.

Location of Controls (TV Set)

For specific use of each control, consult the corresponding page numbers in brackets.

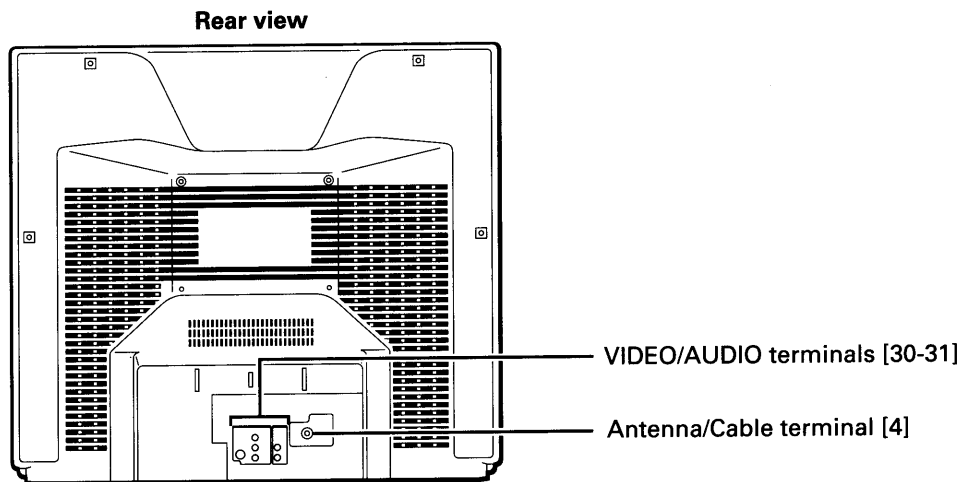
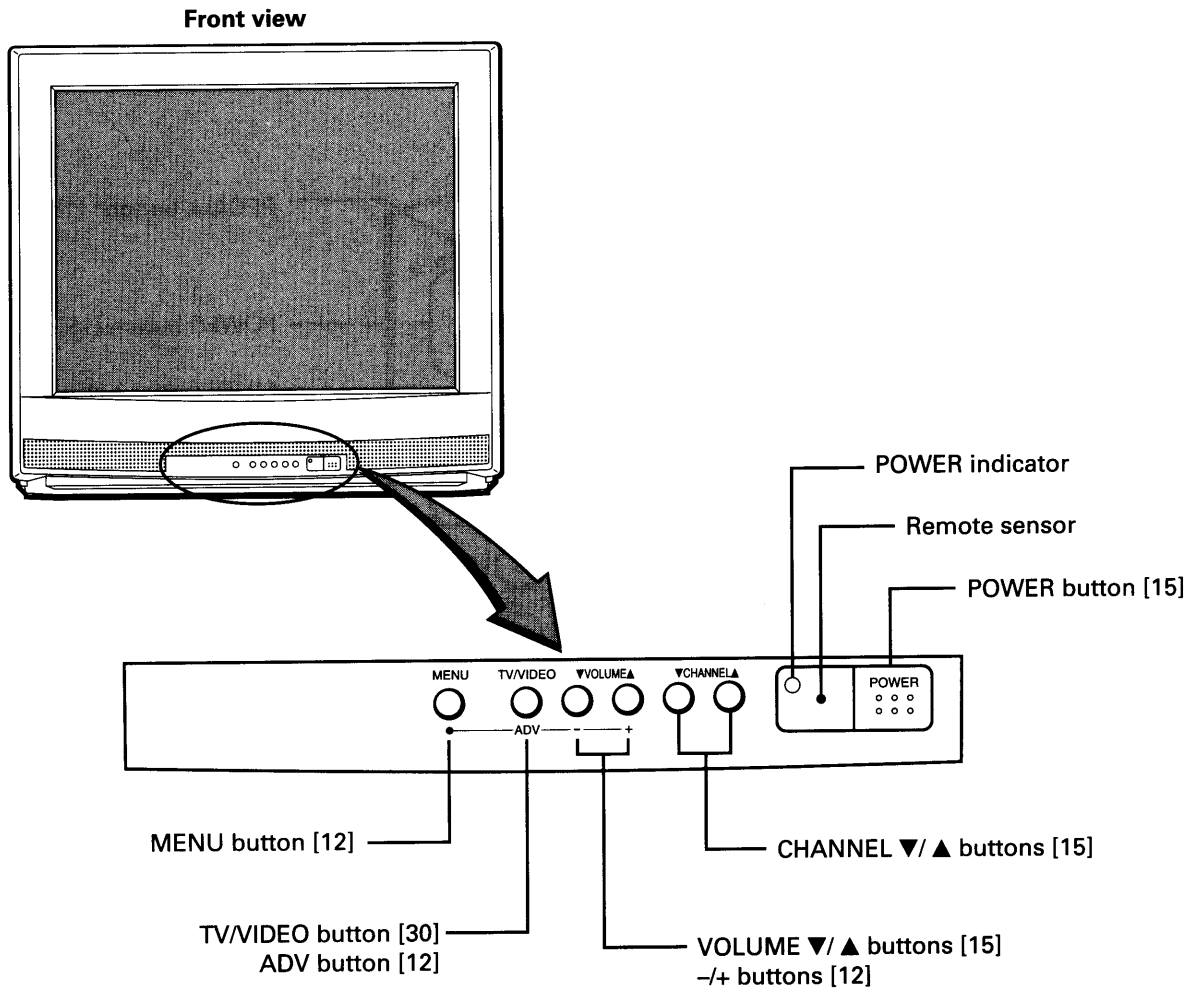

Location of Controls (Remote Control)

Only the buttons that are used to operate the TV set are described here. For details on the use of each control, refer to pages in brackets.

Aim at the remote sensor on the TV

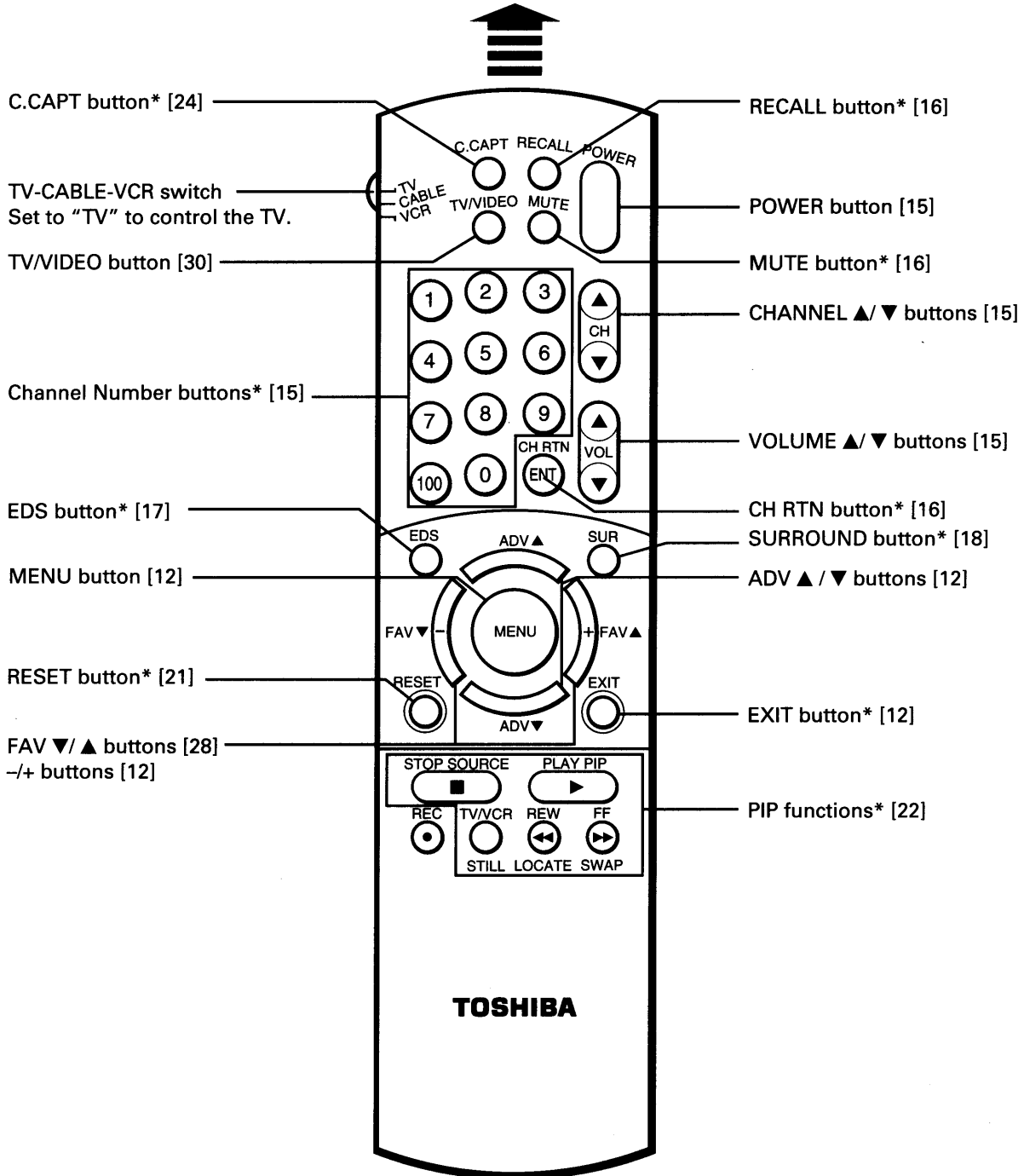

*These functions do not have duplicate locations on the TV set. They can be controlled only with the Remote Control.

Before Using the Remote Control

Introductions

With this Remote Control, you can operate your TV and most models of remote-controlled VCR's and Cable TV converters even if they are different brands. However, this Remote Control must be programmed to control other brands of VCR's and/or Converters. If you will be using your TV set with a TOSHIBA VCR, your remote has already been preprogrammed for you.

- Before attempting to operate your Remote Control, install the batteries according to the section "Installing and replacing batteries" shown below.
- For more detailed instructions, see the section "Programming the Remote Control" on page 9.

Notes:

- After installing new batteries, the Remote Control will set itself to the codes for TOSHIBA's TV and VCR. If you are using the Remote Control to operate equipment that uses different codes, it will have to be reprogrammed for those codes.
- This Remote Control may have functions not available on the original remote control.
- These functions may or may not operate your VCR or Cable TV Converter. Refer to the owner's manuals supplied with the equipment to see which functions are available.
- The remote control supplied with your VCR or Cable TV Converter may have keys not duplicated on this Remote Control. If these functions are desired, the original remote will have to be used.

Installing and replacing batteries

- 1 Place the Remote Control with the face down. Press down on the ridged area of the battery cover and slide it off.

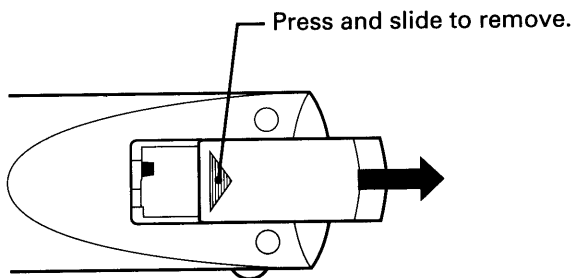

- 2 Place two "AAA" size batteries, matching the + and - signs on each battery to the + and - signs of the battery compartment.

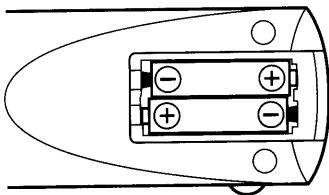

- 3 Replace the battery cover until the lock snaps.

CAUTION:

- Do not throw your batteries into a fire. Dispose of your batteries in a designated disposal area.
- Do not combine used old batteries with new ones.
- Do not mix battery types.

Tips for Best Operation

- For optimum performance, aim the Remote Control directly at the TV from a distance of no more than 16 ft (5m) and be sure there is no obstruction between the Remote Control and the TV.
- If your Remote Control does not always adjust the TV as you wish, you probably need to replace the batteries. The life expectancy of the batteries is about 1 year.
- Remove dead batteries immediately to prevent battery acid from leaking into the battery compartment.
- If you do not intend to use the Remote Control for a long period, remove the batteries.

Using the Remote with VCR or Cable TV Converter

- To control a TOSHIBA VCR, first set the TV-CABLE-VCR switch to "VCR" position. The buttons shown below will then control the VCR. The rest of the buttons operate the TV as usual.
If you have another brand of VCR, you can probably program your Remote to control it.
Details are on page 9.
- To control a cable TV converter, this Remote Control must be programmed to recognize the brand of your converter.
See page 9.
Set the TV-CABLE-VCR switch to "CABLE" position whenever you control the cable TV converter.
The shaded buttons can be used to control the cable TV converter.

Aim at the VCR or cable TV converter

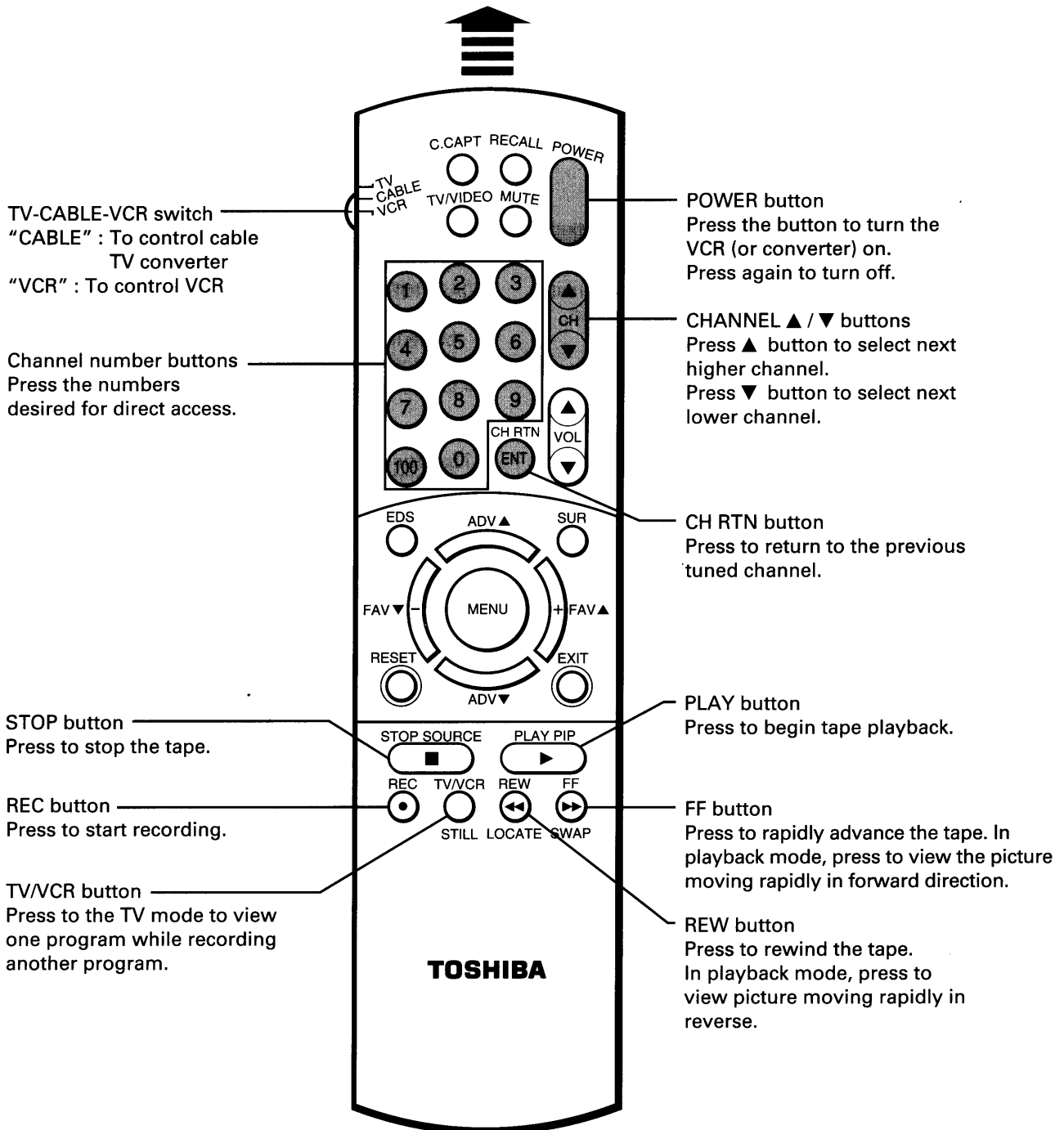

Programming the Remote Control

- This Remote Control is preprogrammed to operate TOSHIBA VCR's.
- To use VCR's other than Toshiba models (or Cable converter), perform the following procedures before operating.

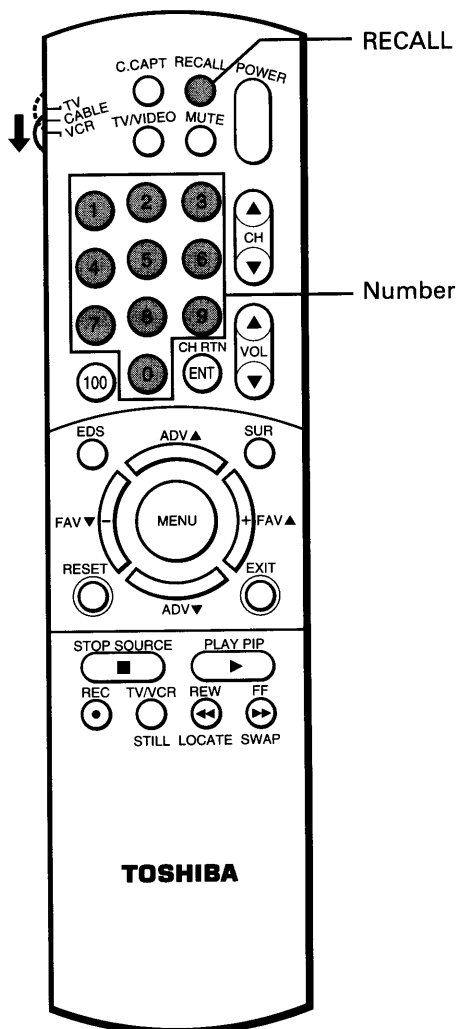

Controlling other brands of VCR's and cable TV converters

1 Refer to the "VCR code table" (or "Cable TV converter code table") on pages 10 and 11 to find the code number that corresponds to the brand name of your VCR (or your converter).

If more than one number is listed, try each one separately until you find the one that works.

2 Set the TV-CABLE-VCR switch to "VCR" (or "CABLE").

3 While holding down the **RECALL** button, press the **Number** buttons for the three digit code number for your brand of VCR (or converter).

4 Point the Remote Control at the VCR (or at the converter) and press **POWER** to test the code number.
-If the right number was entered, the VCR (or the converter) should turn on.
-If the VCR (or the converter) does not respond to the Remote Control, repeat steps 1 to 4 with another code number.

Notes:

- You have to reprogram the Remote Control when you change its batteries.
- Some newer VCR's are capable of working on either of two remote codes. These VCR's have a switch labeled "VCR1/VCR2". If your VCR has this kind of switch, and does not respond to all the code numbers for your VCR brand name, set the switch to another position ("VCR1" or "VCR2") and reprogram the Remote Control.

PREPARATION

Using the Remote with VCR or Cable TV Converter/ Programming the Remote Control

For future reference, write the code you used.

VCR CODE: _____

CABLE CODE: _____

Programming the Remote Control (Continued)

- In some rare cases, you may not be able to operate your non-Toshiba equipment with the supplied Remote Control. This is because your equipment may use a code that is not provided with this Remote Control. In this case, please use the equipment's own remote control.

VCR code table

BRAND NAME	CODE NUMBER		
Adventura	019	ESC	297
Aiko	297	Ferguson	060
Aiwa	019	Fidelity	019
Akai	060,068,080,125, 261	Finlandia	100,123,129
Akiba	091	Finlux	019,061,100,123, 124
Alba	039,228,297,314	Firstline	056,062,064,091, 228
American High	054	Fisher	065,066,073,085, 123
Amstrad	019	Frontech	039
Anam	181	Fuji	052,054
Anitech	091	Funai	019
ASA	056,100	Garrard	019
Asha	259	GE	054,079,084,221
Asuka	056	GEC	100
Audiovox	056	General	071
Baird	019,123	Go Video	251,298
Basic Line	039,091,297	Goldstar	037,056,057
Beaumarck	259	Goodmans	019,039,056,081, 091,297
Bell & Howell	123	Gradiente	019
Blaupunkt	053,181	Graetz	060,123
Brandt	206	Granada	065,100,123
Broksonic	140,203,230,380	Grandin	019,056,091
Bush	091,228,297	Grundig	100
Calix	056	Harley Davidson	019
Canon	054	Harman/Kardon	057,094
Capehart	039	Harwood	087,091
Carver	100	Hcm	091
CCE	091,297	Headquarter	065
CGE	019	HI-Q	066
Cimline	091	Hinari	091,227
Citizen	056,297	Hitachi	019,060,061,084, 124,254
Clatronic	039	Hypson	091
Colt	091	Imperial	019
Condor	039	Interfunk	100
Craig	056,066,091,259	ITT	060,065,123,125
Crown	091,297	ITV	056,297
Curtis Mathes	054,079	JCL	054
Cybernex	259	Jensen	060
Daewoo	039,064,065,297	JVC	027,060,086
Dansai	091	Kaisui	091
Daytron	039	Kendo	125,228
De Graff	061	Kenwood	057,060,065,086
Decca	019,100	KLH	091
Dual	060	Kodak	054,056
Dumont	019,100,123,124	Korpel	091
Dynatech	019	Leyco	091
Elcotech	091	Lloyd	019
Electrohome	056	Loewe	056
Electronic	019	Loewe Opta	100
Electroponic	056	Logik	091,259
Emerex	051	Luxor	062,065,123,125
Emerson	019,021,056,062, 080,087,140,203, 227,228,230,231, 313,314,380	LXI	056
		M-Electronic	019
		Magnavox	019,054,058,100, 129,168
		Magnin	259
		Manesth	064,091
		Marantz	054,057,081,100,
		Marta	056
		Masushita	054
		Matsui	227,228,314
		MEI	054
		Memorex	019,054,056,058, 065,066,067,123, 259
		Memphis	091
		Metz	181
		MGA	062,080
		MGN Technology ..	259
		Minolta	061,124
		Mitsubishi	062,080,086,094, 100,192,233,261,
		Motorola	054,067
		MTC	019,259
		Multitech	019,091
		Murphy	019
		NEC	057,059,060,069, 086
		Neckermann	100
		Nesco	091
		Nikko	056
		Noblex	259
		Nokia	060,065,123,125, 259
		Nordmende	060
		Oceanic	019
		Olympus	054
		Optimus	056,067
		Optonica	067,081
		Orion	140,227,228,314
		Osaki	019,056,091
		Otto Versand	100
		Palladium	056,091
		Panasonic	054,096,115,181, 244
		Penney	054,056,057,059, 061,073,259
		Pentax	061,084,124
		Perdio	019
		Philco	054
		Philips	054,081,100,129
		Phonola	100
		Pilot	056
		Pioneer	086,100
		Portland	039
		Profitronic	259
		Proline	019
		Protec	091
		Pulsar	058
		Pye	100

Quarter 065
 Quartz 065
 Quasar 054,096,115
 Quelle 100
 Radio Shack 019,056
 Radiola 100
 Radix 056
 Randex 056
 RCA 054,061,079,084,
 096,115,124,125,
 168,221
 RCA Unified 079
 Realistic 019,054,056,065,
 066,067,081,085,
 123,259
 Rex 060
 Ricoh 053
 Roadstar 056,091,259,297
 Runco 058
 Saba 060
 Saisho 227,228
 Salora 062,065,125
 Samsung 064,259
 Sanky 058,067
 Sansui 060,086
 Sanyo 065,066,123,259
 SBR 100
 Schaub Lorenz 019,060
 Schneider 019,091,100,129
 Scott 062,064,140,203,
 229,230,231
 Sears 054,056,061,065,
 066,073,085,123,
 124
 SEG 259
 SEI 100
 Seleco 060
 Sentra 039
 Sharp 067,081
 Shintom 091
 Shogun 259
 Siemens 056,123
 Silva 056
 Singer 091
 Sinudyne 100
 Sontec 056
 Sony 051,052,053,054
 STS 061
 Sunstar 019
 Sylvania 019,054,062,100,
 129
 Symphonic 019
 Tandy 019,123
 Tashiko 019
 Tatung 019,060,100
 Teac 019,060
 Technics 054,181

Teknika 019,054,056,071
 Teleavia 060
 Telefunken 060,206
 Tenosal 091
 Tensai 019
 Thomson 060
 Thorn 060,123
 TMK 227,259
 Toshiba 060,062,064,085,
 229,231,385
 Totevision 056,259
 Triumph 227
 Unitech 259
 Universum 019,056,068,100,
 125
 Vector 064
 Vector Research 057,059
 Victor 027,060,086
 Video Concepts 059,064,080
 Videosonic 259
 Wards 019,054,061,066,
 067,081,091,168,
 231,259
 XR-1000 019,054,091
 Yamaha 057,060
 Yamishi 091
 Yokan 091
 Yoko 039,259
 Zenith 052,053,058

Cable TV converter code table

BRAND NAME CODE NUMBER

ABC 020,022,026,030,
 032,033,036,066
 Antronix 041
 Archer 041,058,172
 Belcor 075
 Cable Star 075
 Cabletenna 041
 Cableview 041
 Century 172
 Citizen 172
 Colour Voice 044,050
 Comtronics 059,079
 Contec 038
 Eastern 021
 Garrard 172
 GC Electronics 035,075
 Gemini 034,089
 General
 Instrument 030
 Hamlin 028,039,053,278,
 292
 Hitachi 030

Hytex 026
 Jasco 172
 Jerrold 022,030,031,033,
 034,043,045,066,
 295
 Macom 052
 Magnavox 046
 Memorex 019
 Movie Time 175
 NSC 089,175
 Oak 026,038,267
 Panasonic 040,126
 Paragon 019
 Philips 044,046,047,048,
 049,050,079,172
 Pioneer 042,163
 Popular
 Mechanics 419
 Pulsar 019
 PVP Stereo
 Visual Matrix 022
 RCA 040
 Regal 039,278,292
 Regency 021
 Rembrandt 030,089
 Runco 019
 Samsung 059,163
 Scientific Atlanta ... 025,027,036,296
 346
 Signal 034,059
 Signature 030
 SL Marx 059
 Sprucer 040
 Standard
 Components 174
 Starcom 022,034,066
 Stargate 034,059
 Starquest 034
 STS 175
 Sylvania 020
 Teleview 059
 Texscan 020
 Tocom 031,032,078
 Toshiba 019
 Tusa 034
 Unika 041,172
 United Artists 026
 United Cable 022
 Universal 041,058,075,096
 172,210
 Viewstar 046,079,230
 Zenith 019

Menu Function (General Instructions)

We suggest you familiarize yourself with the procedure before using the Menu function. To adjust any TV feature, the use of the Menu function is required. The adjustments that can be made to the TV appear on the screen.

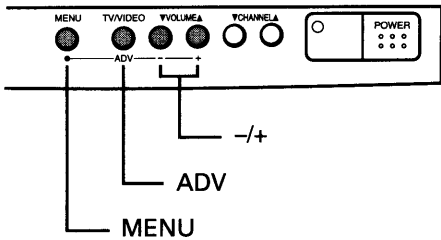

MENU button (on TV and on Remote)

Each time you press **MENU**, the Picture, Audio, Setup or Option menu on-screen display is selected in order, then press **ADV**.

Picture menu

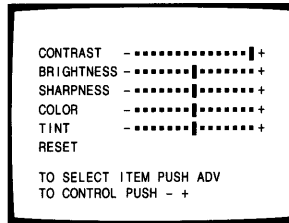

Audio menu

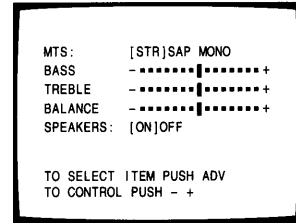

Option menu

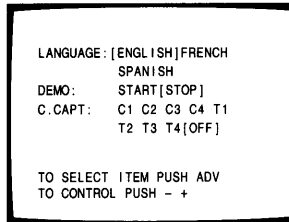

Setup menu

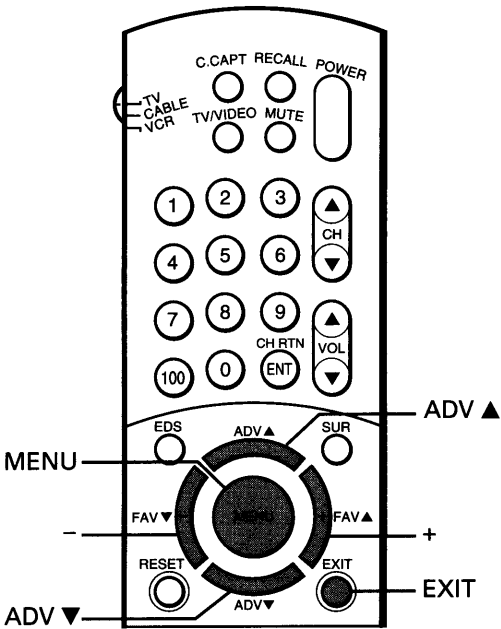
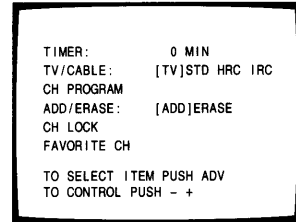

ADV button (on TV and on Remote)

Use **ADV** after you have selected the on-screen menu you want to adjust with the **MENU** button. Each time you press **ADV**, the function to be adjusted will be selected in order.

ADV ▲ button from bottom to top

ADV, ADV ▼ button from top to bottom

The selected function will be displayed in magenta.

- /+ buttons (on TV and on Remote)

Use - /+ to adjust the function you have selected with the **ADV** button.

EXIT button (on Remote)

The above four menu displays will automatically disappear from the screen if no control has been operated for about 15 seconds. If you want to clear the screen of all on-screen displays instantly, press **EXIT**.

Notes:

- The ADV button on the TV will function as the TV/VIDEO button when no menu display is on the screen.
- The -/+ buttons on the TV will function as the VOLUME ▼/▲ buttons when no menu display is on the screen.

Programming Channel Memory

The channel memory is the list of TV channel numbers your TV will stop on when you press the CHANNEL ▲ or ▼ button. **First, use the TV/CABLE and CH PROGRAM functions to preset all active channels in your area.** If necessary, arrange the preset channels with the ADD/ERASE functions so that you can tune into only desired channels.

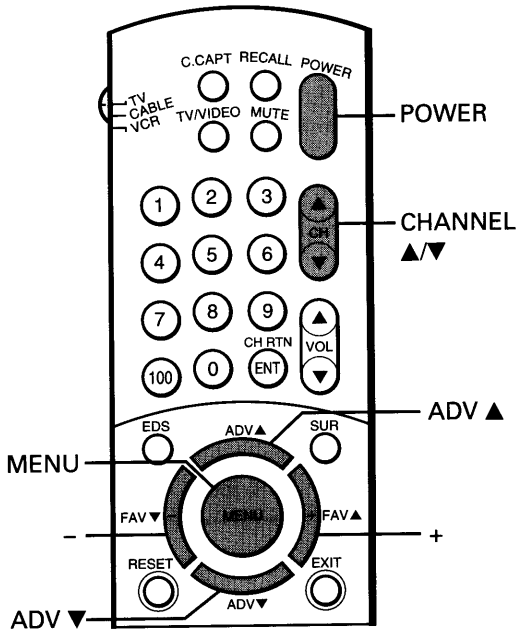
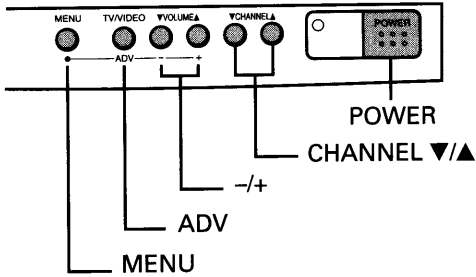

* This TV receives the following TV signals:

1. **TV:** TV broadcasts signals. (VHF channels 2 through 13 and UHF channels 14 through 69)
2. **STD CABLE:** Standard cable TV signals.
3. **HRC CABLE:** Harmonic Related Carrier cable TV signals.
4. **IRC CABLE:** Incremental Related Carrier cable TV signals.

If you are not sure what CABLE system they are using, consult your local cable company.

TV/CABLE function

- 1 Press **POWER** to turn on the TV.
- 2 Press **MENU** repeatedly until the Setup menu is displayed on the screen.
- 3 Press **ADV** repeatedly until "TV/CABLE" is displayed in magenta.
- 4 Press **-** or **+** until the mode that corresponds to your TV signal system is displayed in magenta. Each time you press the button, the TV*, STD*, HRC* or IRC* mode will be selected in order.

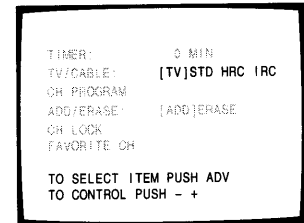
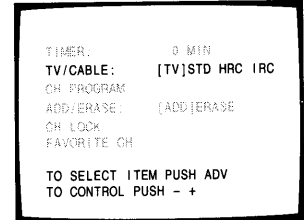

CH PROGRAM function

- 1 Press **MENU** repeatedly until the Setup menu is displayed on the screen.
- 2 Press **ADV** repeatedly until "CH PROGRAM" is displayed in magenta.
- 3 Press **-** or **+** to start channel programming. The TV will automatically cycle through all the TV or CABLE channels depending on the mode selected, and store active channels in the channel memory.
- 4 When channel programming is complete, you will see the message at the right.
- 5 Press **CHANNEL ▲** or **▼** to make sure the channel programming has been done properly.

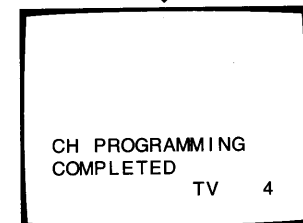
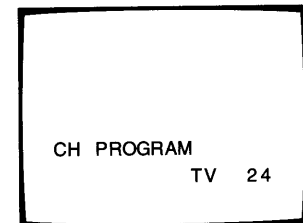
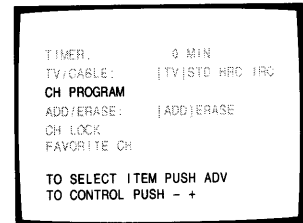

PREPARATION

Menu Function (General Instructions)/ Programming Channel Memory

Programming Channel Memory (Continued)

ADD/ERASE function

After performing the CH PROGRAM function, you can add or erase specific channels.

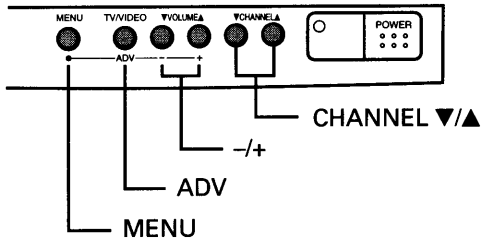

- 1 Select the channel you want to erase using the **CHANNEL ▲** or **▼** button, or select the channel you want to add using the **Channel Number** buttons.
- 2 Press **MENU** repeatedly until the Setup menu is displayed on the screen.
- 3 Press **ADV** repeatedly until "ADD/ERASE" is displayed in magenta.

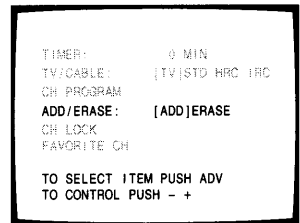

- 4 Press **-** or **+**:
To erase the channel
 Press the button until "ERASE" is displayed in magenta indicating that the channel has been erased from the memory.

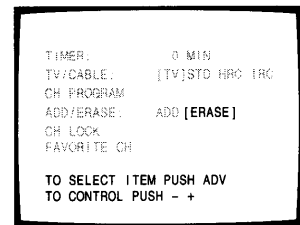

To add the channel
 Press the button until "ADD" is displayed in magenta indicating that the channel has been memorized.

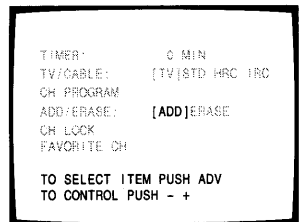

- 5 Repeat steps 1 to 4 for other channels.

You have now completed the channel programming.

CABLE channel reference chart

Number on this TV	1	5	6	14	15	16	34	35	36	37	38	60	61	62	63	64	65	66
Corresponding CABLE channel	A-8	5(A-7)	6(A-6)	A	B	C	U	V	W	AA	BB	XX	YY	ZZ	AAA	BBB	65	66
Number on this TV	67	68	69	92	93	94	95	96	97	98	99	100	101	102	123	124	125	
Corresponding CABLE channel	67	68	69	92	93	94	A-5	A-4	A-3	A-2	A-1	100	101	102	123	124	125	

The above chart is typical of many cable system channel allocations. If in doubt, consult your cable company.

Watching TV Programs

- First set the TV-CABLE-VCR switch on the Remote Control to "TV" position.

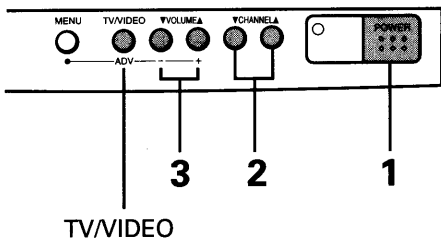

- 1 Press **POWER** to turn on the TV.

To turn off the TV, press **POWER** again.

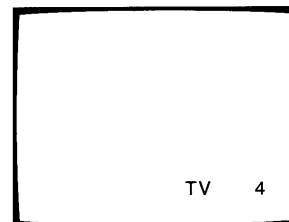

- 2 Select a channel in one of the following two ways.

- **To scan the memorized channels in numerical sequence**
Press **CHANNEL ▲** to select the next higher channel.
Press **CHANNEL ▼** to select the next lower channel.
Press the button again to select the next memorized channels.
- **To select a channel directly**
Press the **Channel Number** buttons (0-9 and 100).
To select channel 4, press "4" (or press "0", "4").
To select channel 38, press "3", "8".
To select channel 125, press "100", "2", "5" in sequence.

If you cannot select certain channels, either TV (off the air) or CABLE channels
Check if the TV/CABLE function is properly set. See page 13.

- 3 Press **VOLUME ▲/▼** to adjust the volume.

To increase the volume, press **▲**.
To decrease the volume, press **▼**.

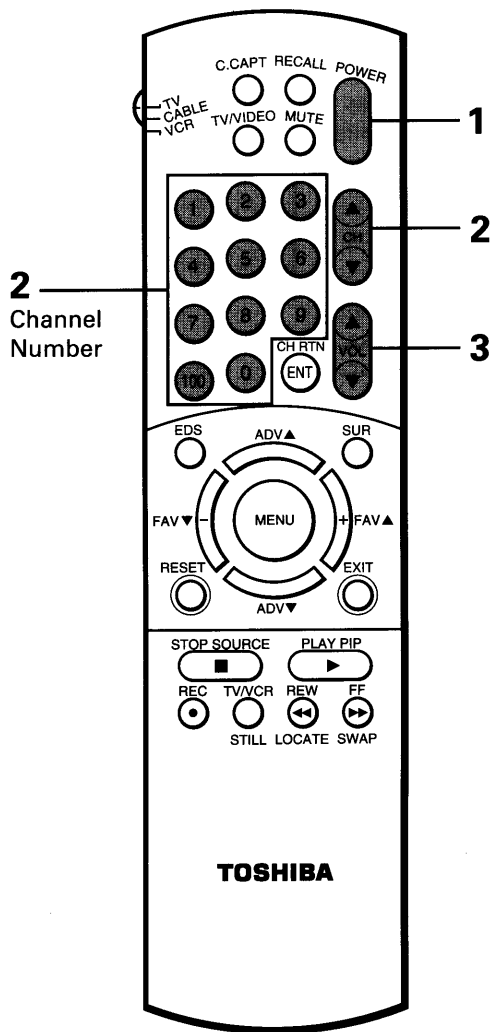
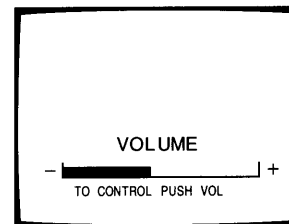

Watching Video Input

The TV/VIDEO button is used to view the signals coming from other devices like VCR's or Laserdisk Players connected to this TV. Details are on page 30.

Auto-Power-Off

If a vacant channel is tuned or TV broadcast for a day is finished, the TV will automatically turn off after about 15 minutes. This feature does not operate in the VIDEO mode.

Last Mode Memory

If the power is cut off while you are viewing the TV and the power is resupplied, the TV is turned on automatically by the *Last Mode Memory* feature. If the power is going to be off or when you leave home for a long time, remove the power plug from the wall outlet to prevent the TV from turning on in your absence.

Note:

The VOLUME ▼/▲ buttons on the TV function as the -/+ buttons while any of the menu displays (Picture, Audio, Setup or Option) are on the screen.

Convenient Remote Functions

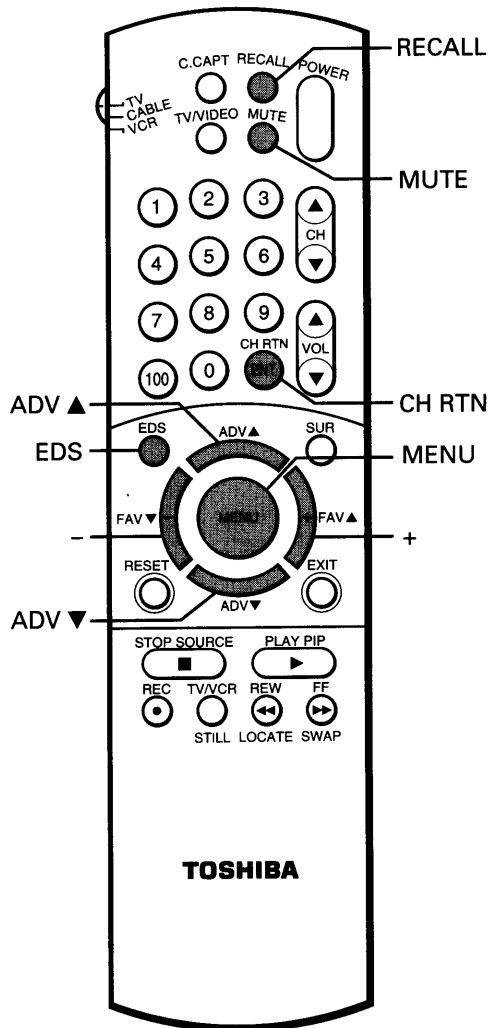

Displaying on-screen information

Press **RECALL** to display the following on-screen information.

- Channel number
- VIDEO mode selected
- Stereo or SAP audio status
- Closed Caption or Text program status

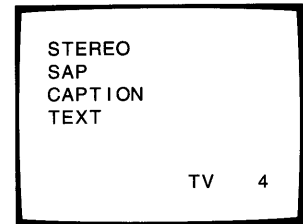

Muting the sound

Press **MUTE** to mute the sound. The word "MUTE" will be displayed on the screen as shown. This is useful during telephone calls or other interruptions.

To restore the sound, press **MUTE** again.

Note: When the MUTE button is pressed, the Closed-Captioned feature "C1" is activated. ("MUTE" on-screen display will disappear.) To deactivate, press the MUTE button again. (This feature only functions when the Closed Caption mode is set to "OFF".)



Changing quickly between two channels

Press **CH RTN** to return to the last channel viewed.

This is useful should you want to view two channels. This allows you to view two programs without entering an actual channel number each time.

To operate this function

- 1 Select the first channel you want to view.
- 2 Select the other channel with the Channel Number buttons.
- 3 Press **CH RTN**.
The previous channel will return.

Each time you press **CH RTN**, the TV will switch back and forth between the two channels.

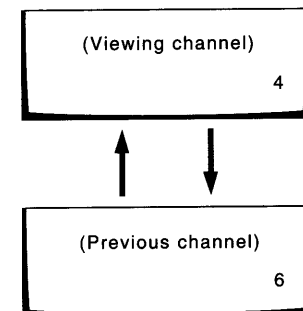

Displaying the EDS information

Press **EDS** to display the following EDS (Extended Data Service) information for about 10 seconds.

- Network name ①
- Program name ②
- Program type ③
- Time in show ④
- Program length ⑤

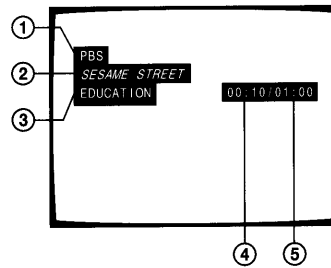

Some of the above information may not be displayed.

If the TV program you are watching does not include the EDS information

"NO EDS INFORMATION" will be displayed instead for about 10 seconds when you press **EDS**.

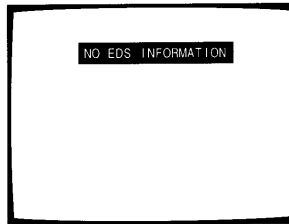

Setting the off-timer

With the off-timer, you can set the TV to turn off automatically after a predetermined period of time (up to 3 hours, in 10 minute units).

- 1 Press **MENU** repeatedly until the Setup menu is displayed on the screen.
- 2 Press **ADV** repeatedly until "TIMER" is displayed in magenta.

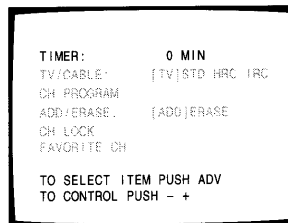

- 3 Press **+** or **-** to enter the length of time you want the TV to stay on. Each time you press the button, the time display will increase (+) or decrease (-) by 10 minutes.

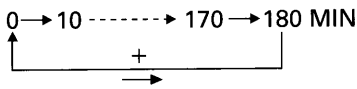
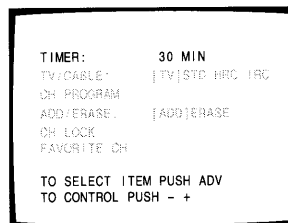

Notes:

- To cancel the off-timer, press **POWER**. To turn the TV on again, press **POWER**.
- The off-timer setting can also be performed using the **MENU**, **ADV** and **-/+** buttons on the TV.

Selecting Stereo/SAP Broadcasts

The MTS (Multi-channel TV Sound) feature allows you to improve your TV viewing with high fidelity stereo sound. This TV also allows you to activate or deactivate the stereo surround sound effect. MTS also provides for an extra channel, SAP (Second Audio Program), used to transmit a second language or other audio information.

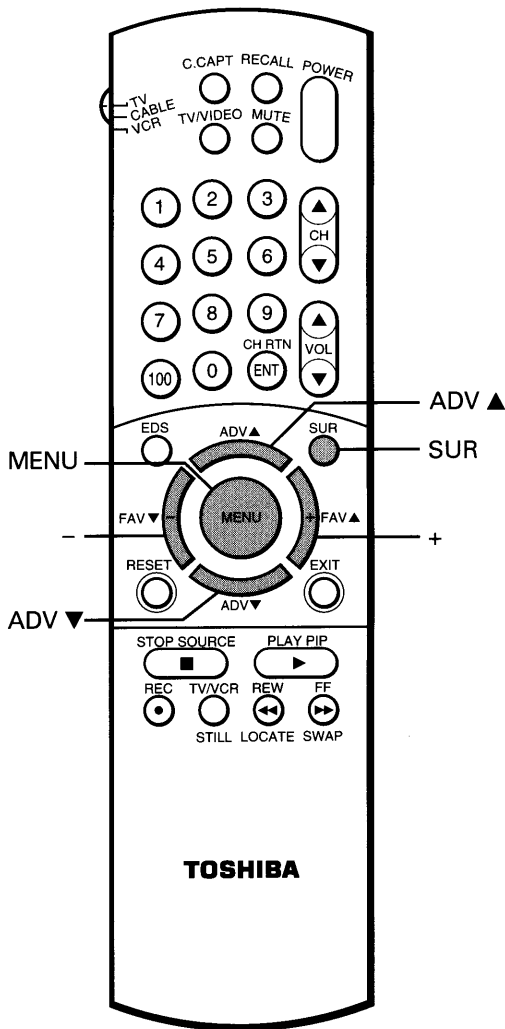
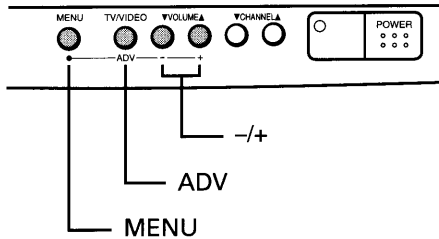

Listening to stereo sound

- 1 When the TV receives a stereo broadcast, the word "STEREO" is displayed on the screen whenever the TV is turned on, a channel is selected, or the RECALL button is pressed.
- 2 Press **MENU** repeatedly until the Audio menu is displayed on the screen.
- 3 Press **ADV** repeatedly until "MTS" is displayed in magenta. If a stereo broadcast is received, "STR" will be displayed in yellow.
- 4 Press **-** or **+** until "STR" (stereo) is displayed in magenta.

Normally this function can be left in "STR" mode. Your TV will then automatically reproduce either stereo or monaural sound, whichever is broadcast.

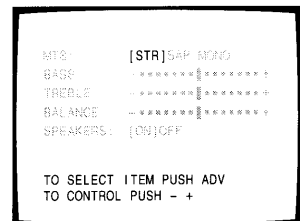
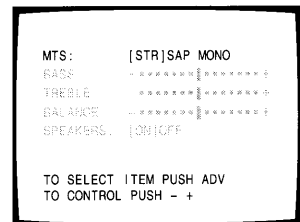

If the stereo sound is noisy

Be sure you have selected "STR" mode if broadcast is in stereo. However, if a broadcast signal is not strong enough, and noise-free stereo sound is not available, select "MONO" (monaural) mode. The noise should be reduced.

Activating surround sound effect

- 1 Select the STEREO mode as described above.
 - 2 Press **SUR** repeatedly until "SURROUND ON" is displayed in magenta.
- The surround function has now been activated.

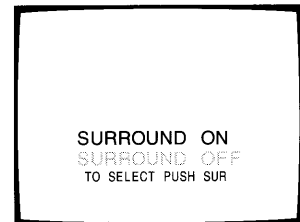

Note: "MTS" function is not available while in the VIDEO mode.

To deactivate the surround effect

Select "SURROUND OFF" in step 2 above.

Note: Normally you can leave the STEREO mode turned on and the surround function activated. The TV will automatically produce either surround stereo or monaural, whatever is broadcast.

Listening to second language

- 1** When the TV receives a SAP broadcast, the word "SAP" is displayed on the screen.



- 2** Press **MENU** repeatedly until the Audio menu is displayed on the screen.
- 3** Press **ADV** repeatedly until "MTS" is displayed in magenta. If a SAP broadcast is received, "SAP" will be displayed in yellow.

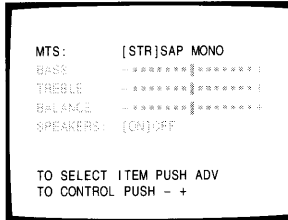

- 4** Press - or + until "SAP" is displayed in magenta. You will hear only the second language from the left and right speakers.

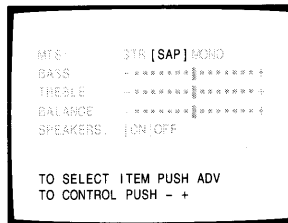

Adjusting the Picture

You can adjust the picture quality (CONTRAST, BRIGHTNESS, SHARPNESS, COLOR and TINT) to suit your taste.

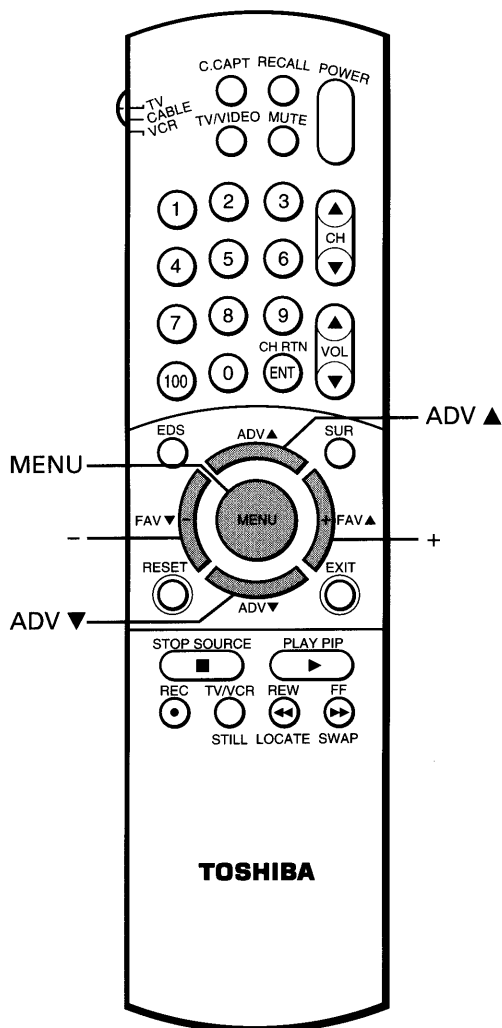
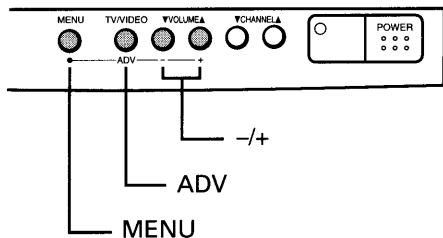

To adjust the picture quality

- 1 Press **MENU** repeatedly until the Picture menu is displayed on the screen.
- 2 Press **ADV** repeatedly until the item you want to adjust is displayed in magenta.

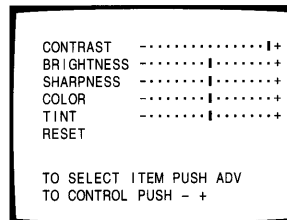

- 3 Press **-** or **+** to adjust the level.

Example: CONTRAST adjustment mode display

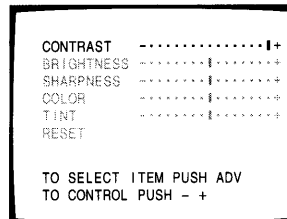

Selection	Pressing	
	-	+
CONTRAST	lower	higher
BRIGHTNESS	darker	lighter
SHARPNESS	softer	sharper
COLOR	paler	deeper
TINT	reddish	greenish

To reset the Picture and Sound adjustments to the factory-preset level (maximum CONTRAST and all other adjustments centered)

- 1 Press **MENU** repeatedly until the Picture menu is displayed on the screen.
- 2 Press **ADV** repeatedly until "RESET" is displayed in magenta.

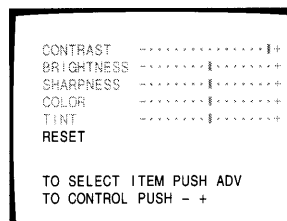

- 3 Press **-** or **+**.

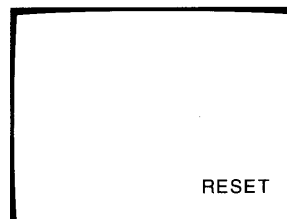

Note: You can also use the RESET button on the Remote Control. (See page 21.)

Adjusting the Sound

You can adjust the sound quality (BASS, TREBLE and BALANCE) to suit your taste.

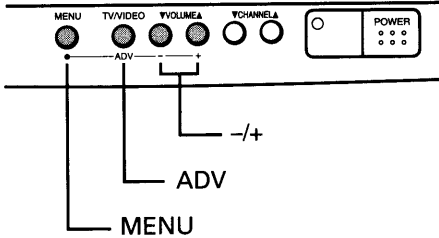

Adjusting the sound quality

- 1 Press **MENU** repeatedly until the Audio menu is displayed on the screen.
- 2 Press **ADV** repeatedly until the item you want to adjust is displayed in magenta.

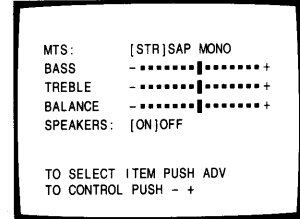

- 3 Press **-** or **+** to adjust the level.

Example: BASS adjustment mode display

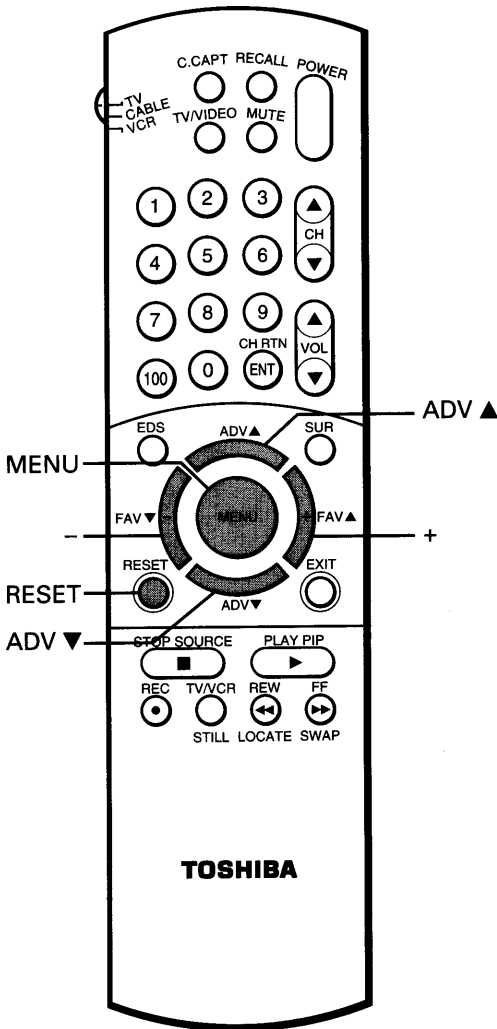
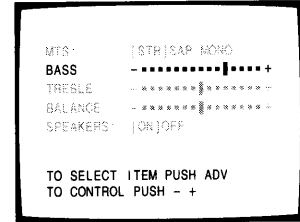

Selection	Pressing	
	-	+
BASS	weaker	stronger
TREBLE	weaker	stronger
BALANCE	decreases the right channel	decreases the left channel

RESET button (on the Remote Control)

To reset the picture and audio adjustments to the factory-preset level (maximum CONTRAST and all other adjustments centered)

Press **RESET**.

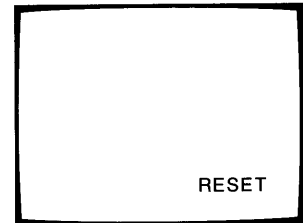

Note: The "SPEAKERS" function is explained on page 31.

Watching Picture-in-Picture

In addition to the main picture, another TV program or video source being received through the VIDEO input jacks can be displayed simultaneously as a small picture. This is called PIP (Picture-in-Picture).
Be sure to connect a VCR with the VIDEO/AUDIO cables.

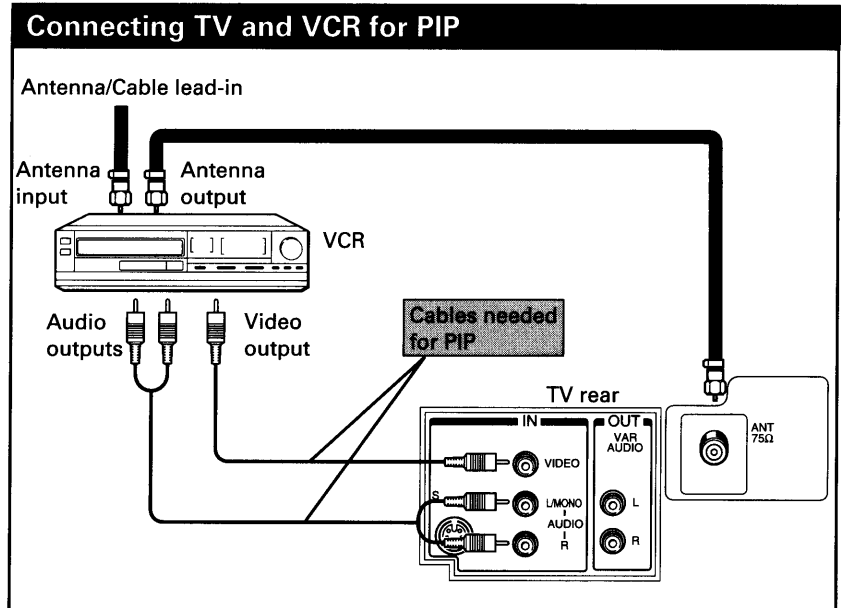
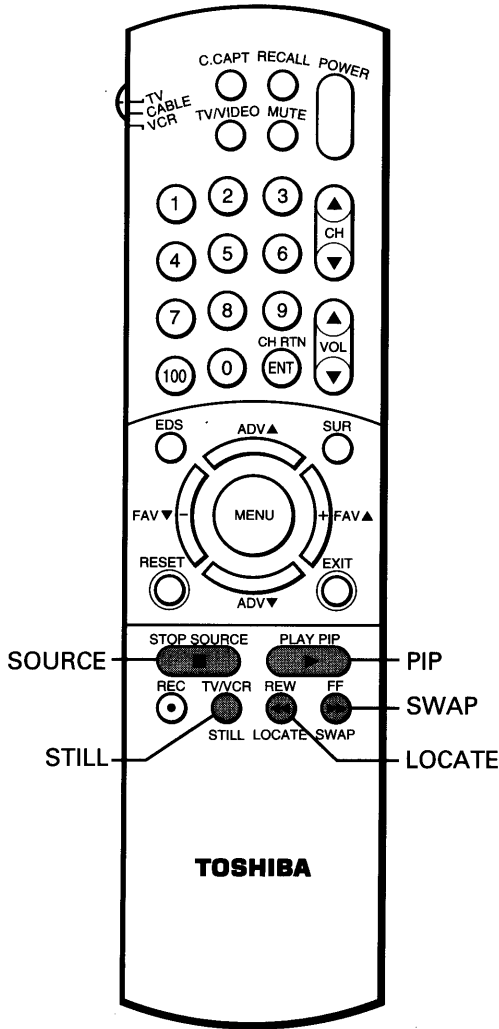

Displaying a small picture

1 Press **PIP** once to display a small picture.
 The 1/9 size window picture will appear.
 If you press **twice**: The 1/16 size window picture will appear.

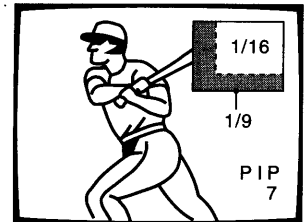

2 Press **SOURCE** to select "VIDEO" input source for the small picture.
 The selected source will be displayed in magenta.

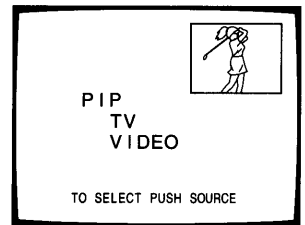

3 Select channels for the PIP using the VCR's channel keys.

To turn off the small picture, press PIP

- **Twice**, if you watch the 1/9 size window picture.
- **Once**, if you watch the 1/16 size window picture.

Using advanced functions

To change the position of the small picture

Press **LOCATE** repeatedly when a small picture is displayed. The display position of the small picture will change in order.

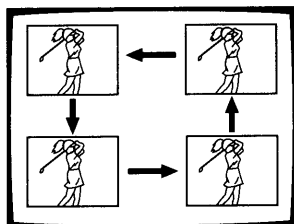

To switch the main and small picture

Press **SWAP** when a small picture is displayed.

The main and small pictures will switch.

To switch them again, press **SWAP** again.

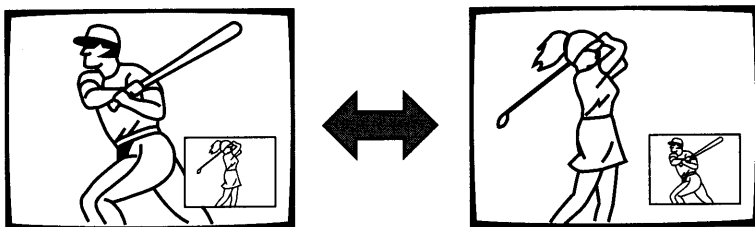

To freeze the small picture

Press **STILL** when a small picture is displayed.

The small picture will become a still picture.

To return to a moving picture, press **STILL** again.

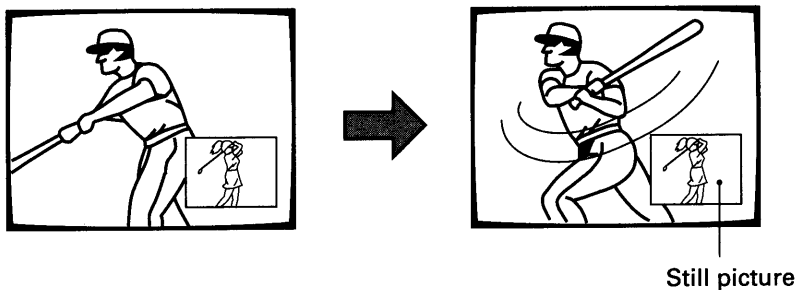

Using Closed-Captioned Function

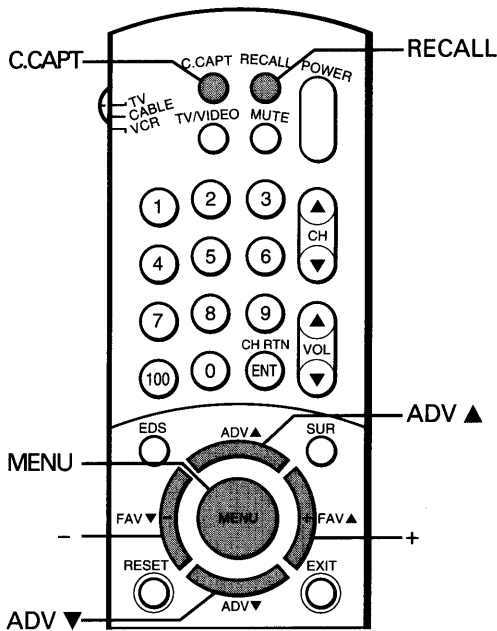
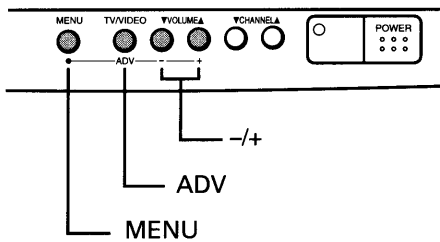
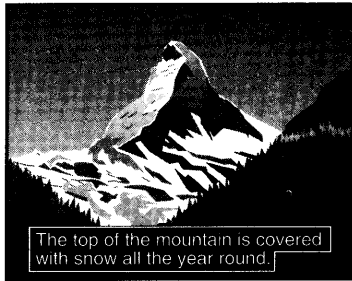

Note:

- A closed-captioned signal may not be decoded in the following situations.
- When a video tape has been dubbed.
 - When the signal reception is weak.
 - When the signal reception is non-standard.

To view captions

Closed-captioning is a printed version of the dialogue, narration, and/or sound effects of a TV program. Captions will appear at either the top or bottom of the screen during captioned broadcasts as shown. Captioning is especially helpful for hearing impaired individuals.

- 1 Select the desired program.
- 2 Press **RECALL** to check if the program is being captioned. If it is, the word "CAPTION" is displayed on the screen. The captioned programs are usually notated on your local TV listings by its service marks such as "CC".
- 3 Press **C.CAPT** on the Remote Control to call up the CLOSED CAPTION menu. Usable selections are displayed in yellow.

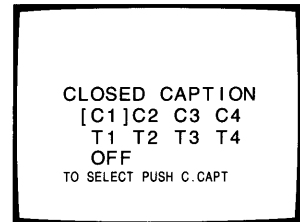
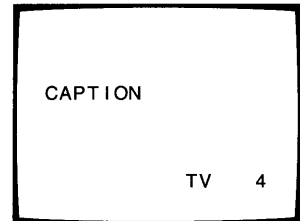

Press **C.CAPT** repeatedly until "C1", "C2", "C3" or "C4" is displayed in magenta. ("C1" stands for CAPTION 1, for example.) Select "C1" for translation of the primary language in your area. Select "C3" for captioning information usually of secondary languages. "C2" or "C4" carry Closed Captioning but not necessarily in the same time frame as the sound from the program.

You can also select this feature using the on-screen menu function.

- 1 Press **MENU** repeatedly until the Option menu is displayed on the screen.
- 2 Press **ADV** repeatedly until "C.CAPT" is displayed in magenta.
- 3 Press - or + to select "C1", "C2", "C3" or "C4".

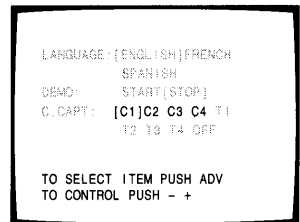
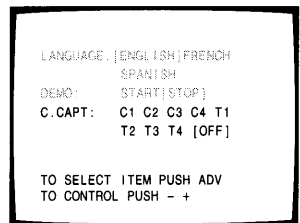

To deactivate this feature

Select "OFF" in the closed caption mode display.

To view text

Text is information that is presented using from one half to full television screen. It is usually not related to the program. For example, it could be a listing of the closed-captioned programs, news, weather information or stock market reports.

- 1 Select the desired program.
- 2 Press **RECALL** to check if the program includes text information. If it is, the word "TEXT" is displayed on the screen.

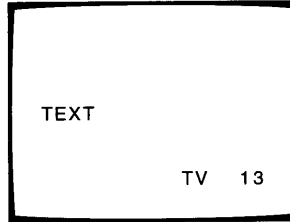

	Temps		Current Weather
	F	C	
LONDON	51	11	Clear
MOSCOW	57	14	Cloudy
PARIS	53	12	Clear
ROME	66	19	Cloudy
TOKYO	65	18	Rain

- 3 Press **C.CAPT** on the Remote Control to call up the CLOSED CAPTION menu. Usable selections are displayed in yellow.
- Press **C.CAPT** repeatedly until "T1", "T2", "T3" or "T4" is displayed in magenta. ("T1" stands for TEXT 1, for example.)

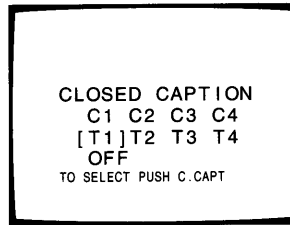

You can also select this feature using the on-screen menu function.

- 1 Press **MENU** repeatedly until the Option menu is displayed on the screen.
- 2 Press **ADV** repeatedly until "C.CAPT" is displayed in magenta.
- 3 Press **-** or **+** to select "T1", "T2", "T3" or "T4".

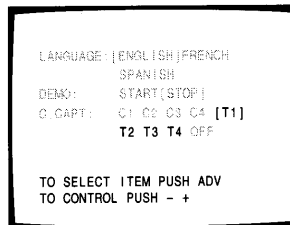
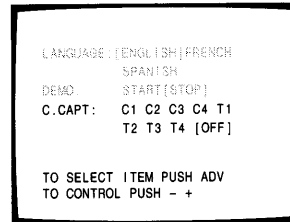

To deactivate this feature

Select "OFF" in the closed caption mode display.

Note: If you select a closed-captioned channel and the "TEXT" mode, the text screen always appears. However, text characters are not displayed when no signal is aired.

Locking Channels

With this function you can lock out specific channels (for example a channel that you do not want your children to watch) by entering your own 4-digit code. The TV will not be able to tune them for the next 24 hours, unless you cancel the locked out channels. This TV has 4 memory spaces total for the TV mode and CABLE mode respectively.

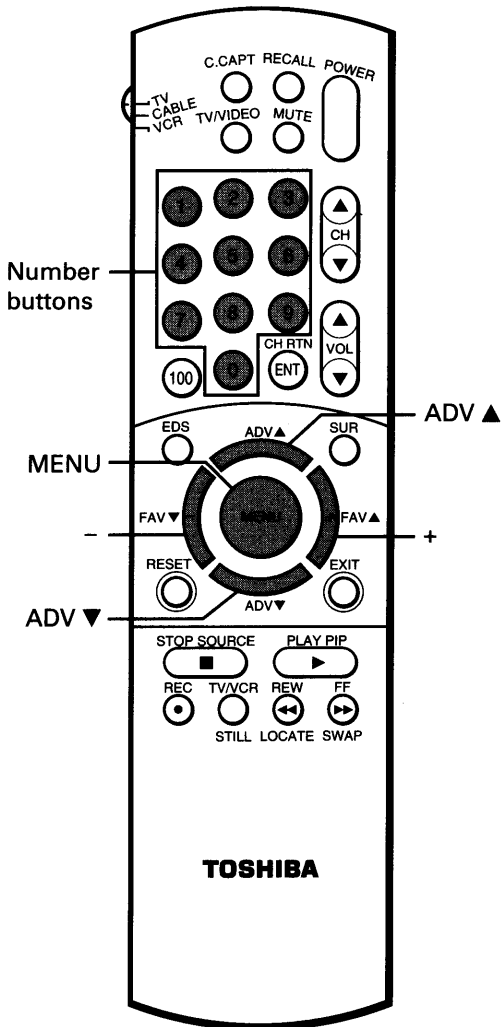
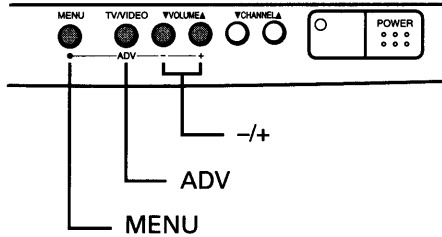

Locking out channels

1 Select a channel you want to lock out.

Example: channel 4

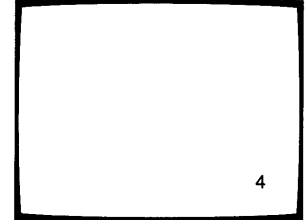

2 Press **MENU** repeatedly until the Setup menu is displayed on the screen.

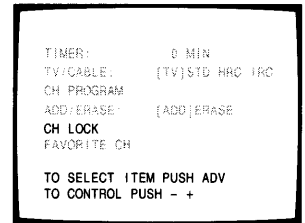

3 Press **ADV** repeatedly until "CH LOCK" is displayed in magenta.

4 Press - or + to call up the channel lock adjustment display shown below. Each time you press the button, you are guided between "SET" and "CLEAR". Select "SET"

SET
↓
↑
CLEAR

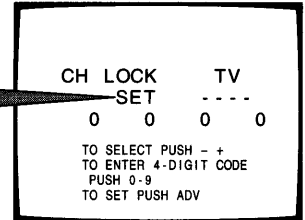

5 Press Number buttons (0 - 9) to enter a 4-digit code. The numbers you enter will replace the dashes in the display. **Pick a number that is easy to remember.**

Example: To enter "1234"
Press 1, 2, 3 and 4 in order.

1 --- → 1 2 --- → 1 2 3 --- → 1 2 3 4

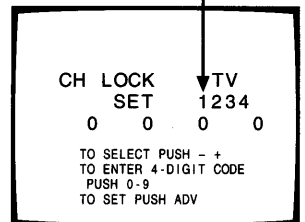

- 6** Press **ADV** to lock out the channel.
The display at the right will appear on the screen for about 4 seconds.

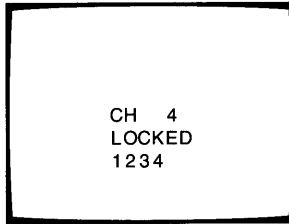

- 7** Repeat steps 1 to 6 for other channels.
This TV has 4 memory spaces total for the TV mode and CABLE mode respectively.

Note: If a different code number is used whenever you lock out a channel, the last one has priority over the preceding ones.

- 8** Select another channel, or turn off the TV if desired.

Restoring channels

- 1** Select "CLEAR" following the steps 2 to 4 on the previous page.

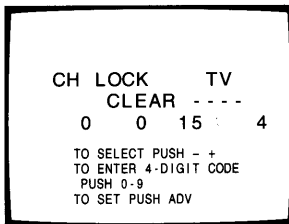

- 2** Press the 4-digit code used to lock out the channels with the Number buttons.

- 3** Press **ADV**.
If you have entered the correct code
The display shown at the right appears.

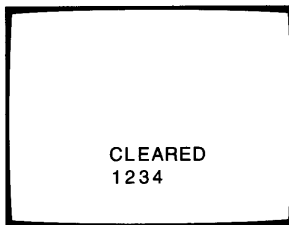

If a wrong code has been entered
These messages appear. Try to enter the correct code again.

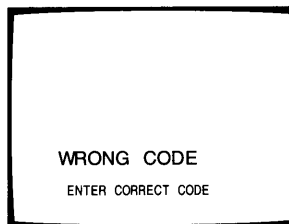

If you want to know the channels you have locked out
Call up the channel lock adjustment mode using the Setup menu.

Programming Your Favorite Channels

The Favorite Channel Programming feature allows you to program up to 12 of your favorite channels. Once programmed, you can use the FAV ∇/\blacktriangle buttons on the Remote Control to scan through only your favorite channels, skipping other channels you do not normally view. You can use the CHANNEL \blacktriangle/∇ buttons to scan through all the channels you programmed in the TV's memory.

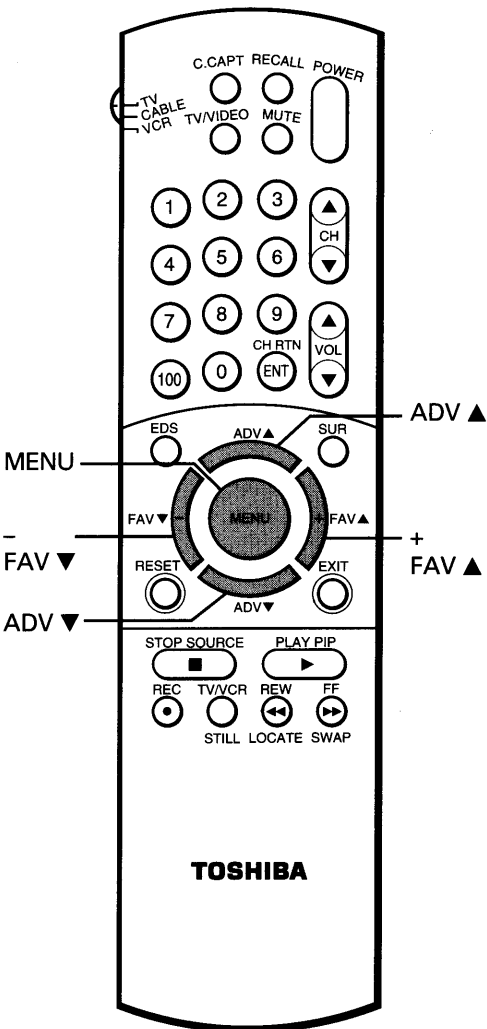
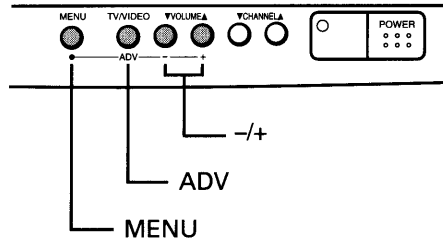

Programming your favorite channels

- 1 Select a channel you want to program.

Example: channel 2

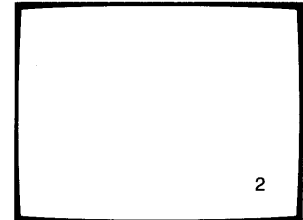

- 2 Press **MENU** repeatedly until the Setup menu is displayed on the screen.

- 3 Press **ADV** repeatedly until "FAVORITE CH" is displayed in magenta.

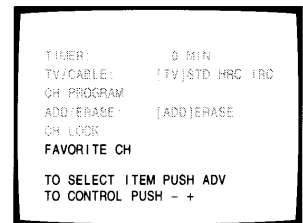

- 4 Press **-** or **+** to display the FAVORITE CH program menu. Each time you press **-** or **+**, you are guided between "SET" and "CLEAR".

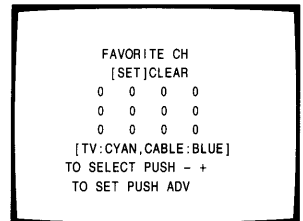

- 5 **To program channels:** Select "SET", then press **ADV** until the channel number to be programmed ("2" in this example) replaces "0" on the display.

To erase channels: Select "CLEAR", then press **ADV** until "0" replaces channel number to be erased, "2" for example.

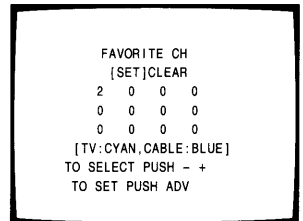

- 6 Repeat steps 1 to 5 for other channels.

Selecting your favorite channels

To select your favorite channels you have programmed, use the FAV ∇/\blacktriangle buttons on the Remote Control instead of using the CHANNEL \blacktriangle/∇ buttons.

Changing On-Screen Display Language

Three different languages (ENGLISH, FRENCH and SPANISH) are available for the on-screen displays (adjustment menus, and messages), and you can choose the desired one.

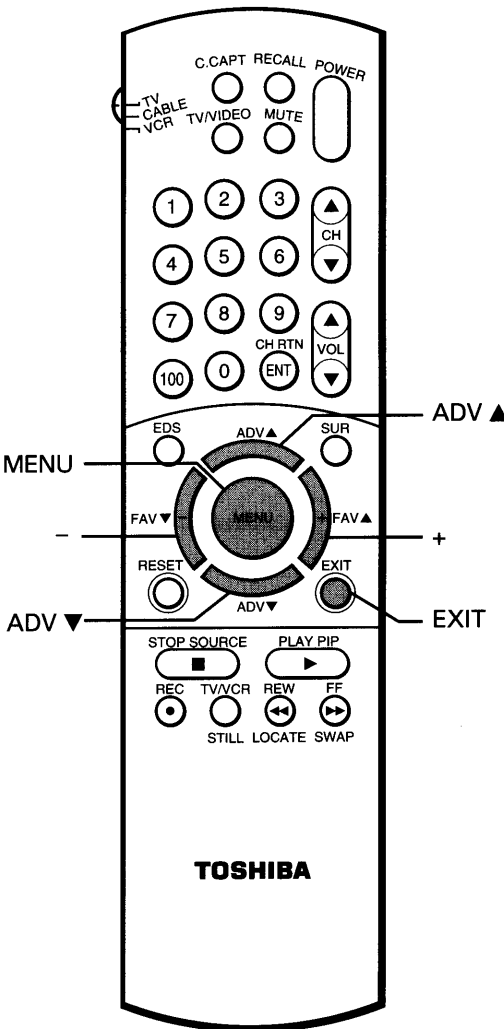
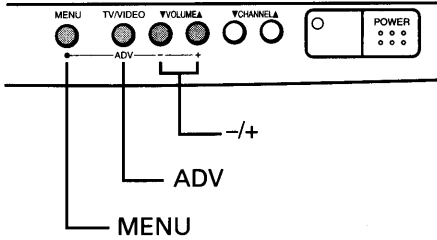

Selecting a language

- 1 Press **MENU** repeatedly until the Option menu is displayed on the screen.
- 2 Press **ADV** repeatedly until "LANGUAGE" is displayed in magenta.
- 3 Press **-** or **+** until your desired language is displayed in magenta. If you select "FRENCH" for example, the display language changes to French.

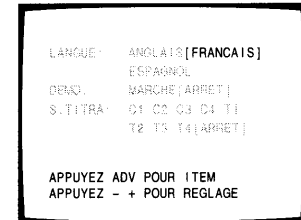
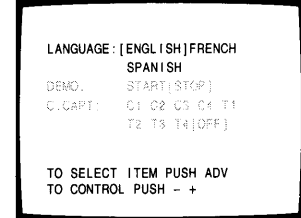

Demonstration Mode

When this function is activated, your TV will automatically display a variety of its on-screen menus and special features. This function is provided for demonstration purpose only.

Starting the on-screen demonstration

- 1 Select "DEMO" in the Option menu by pressing **MENU** and **ADV** buttons.
- 2 Press **-** or **+** until "START" is displayed in magenta.

The demonstration will start after about 15 seconds.

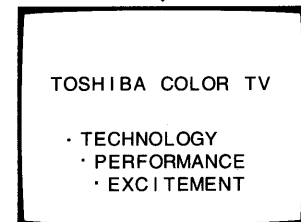
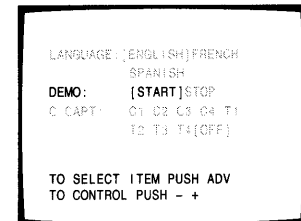

To stop the demonstration
Press **EXIT** or select "STOP" in step 2.

Connecting a VCR

Connect VIDEO/AUDIO IN jacks on the TV rear to the video/audio output jacks of a VCR, Laser disk Player, Camcorder, etc. for playback of video material. The S-VIDEO jack is provided for direct S-video connection from **SVHS** VCR (or camcorder). When the S-video cable is connected to the S-VIDEO IN jack, the VIDEO plug should not be connected.

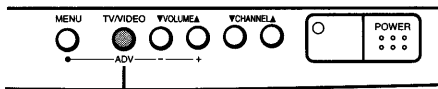
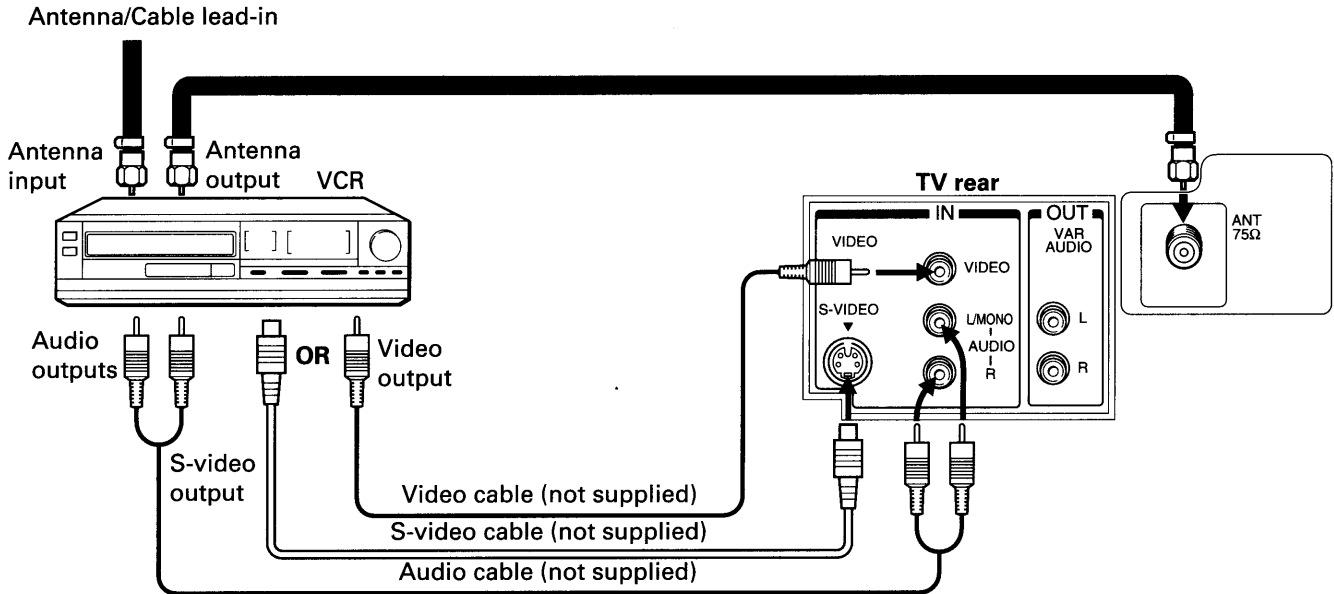

TV/VIDEO

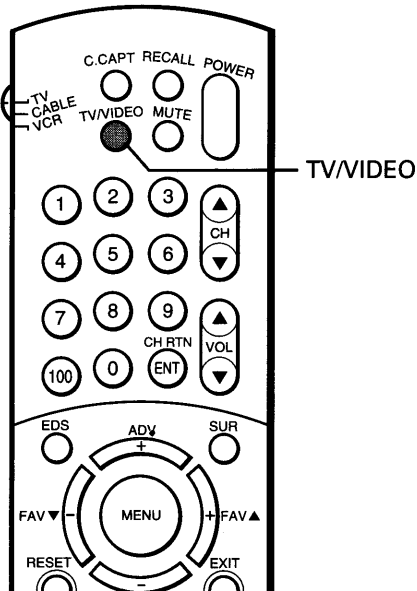

Preparing for use

To operate your TV and video equipment properly, refer to the instructions furnished with the video equipment.

- 1 Turn the TV and VCR ON.
- 2 Press **TV/VIDEO** on the Remote Control or on the TV until "VIDEO" is displayed in magenta.

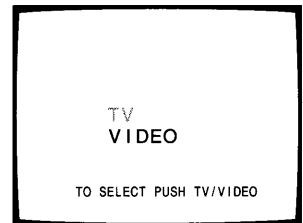

- 3 Operate your VCR normally.

Notes:

- If you connect a monaural VCR, connect the audio output of the VCR to the L/MONO jack on the TV.
- The S-VIDEO jack accepts separated luminance/chrominance (Y-C) signals conforming to the NTSC standard.

Connecting an Audio Amplifier

Connect the VARIABLE AUDIO OUT jacks to the auxiliary input jacks on the stereo amplifier. You can control the audio level using the Remote Control for this TV.

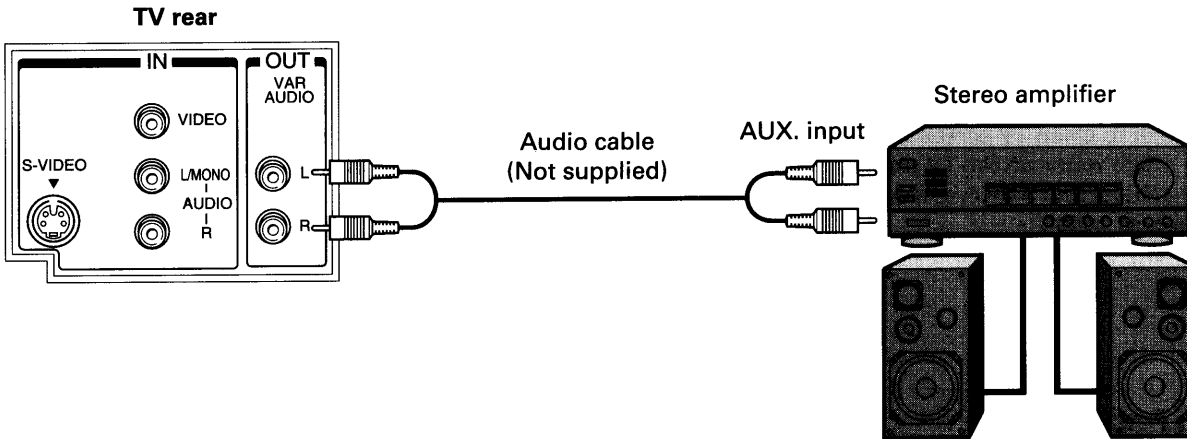

Preparing for use

- 1 Turn the TV and the stereo amplifier ON.
- 2 Adjust the VOLUME buttons on the TV for a moderate listening level.
- 3 Disconnect the built-in speakers following the instructions at the right.
- 4 Adjust the volume control on the stereo amplifier for a moderate listening level.
- 5 Control of the audio can now be done using the VOLUME and MUTE buttons on the Remote Control of the TV, and using the Audio menu items (BASS, TREBLE and BALANCE).

Disconnecting the built-in speakers

- 1 Press **MENU** repeatedly until the Audio menu is displayed on the screen.
- 2 Press **ADV** repeatedly until "SPEAKERS" is displayed in magenta.
- 3 Press **-** or **+** until "OFF" is displayed in magenta.

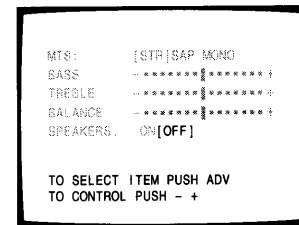
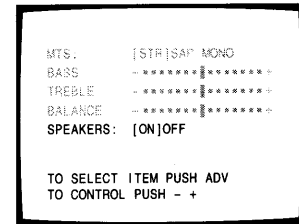

The built-in speakers will be disconnected.

To use the built-in speakers again
Select "ON" in step 3 above.

Cleaning and Care

WARNING: TV sets use High Voltage. Do not try to remove the cabinet back. Refer servicing to qualified service personnel.

- To clean the TV screen:
 1. First remove the plug from the power outlet to avoid possible shock hazard.
 2. Use a clean cellulose sponge or chamois cloth dampened with a solution of mild detergent and warm water to clean TV screen and trim. Do not use too much water on the TV screen. Water spills into the cabinet and may cause damage to the TV. Avoid excess water.
 3. Remove any extra moisture with the same cloth or a dry one.
 - To maintain the finish and appearance of the cabinet, polish it from time to time with a quality furniture polish.
- Caution:** Never use strong solvents such as thinner, benzene or other chemicals on or near cabinet, as they might damage the finish of the cabinet.

Specifications

TELEVISION SYSTEM:	NTSC standard
CHANNEL COVERAGE:	VHF; 2 through 13 UHF; 14 through 69 Cable TV; mid band (A-8 through A-1, A through I) super band (J through W) hyper band (AA through ZZ, AAA, BBB) ultra band (65 through 94, 100 through 125)
POWER SOURCE:	120V AC, 60Hz
POWER CONSUMPTION:	93W (average)
AUDIO POWER:	5W + 5W
SPEAKER TYPE:	Two 2-3/8 x 4-3/4 inches (60 x 120 mm)
VIDEO/AUDIO TERMINALS:	S-VIDEO INPUT Y-INPUT: 1V(p-p), 75 ohm, negative sync. C-INPUT: 0.286V(p-p) (burst signal), 75 ohm VIDEO/AUDIO INPUT VIDEO: 1V(p-p), 75 ohm, negative sync. AUDIO: 150mV(rms) (30% modulation equivalent, 47k ohm) VARIABLE AUDIO OUTPUT 0 - 350mV(rms) (30% modulation equivalent, 4.7k ohm)
DIMENSIONS:	Width 26-21/32 inches (677mm) Height 24-11/32 inches (618mm) Depth 21-49/64 inches (553mm)
MASS:	74.3 lbs. (33.7 kg)
SUPPLIED ACCESSORIES:	Remote Control with 2 size "AAA" batteries Antenna adaptor
OPTIONAL TV STAND	ST2712

Design and specifications are subject to change without notice.

Before Calling Service Personnel

Before calling service personnel, please check the following chart for a possible cause of the problem you are experiencing. A minor adjustment on your part may eliminate the problem and restore your TV reception.

Symptoms	Check	Adjustments
● No picture, no sound	<ul style="list-style-type: none"> ● Be sure power cord is plugged in. ● May be station trouble. ● Check antenna connections. ● Check antenna for broken wires. 	<ul style="list-style-type: none"> ● Press POWER button. ● Try another channel.
● No sound, picture OK	<ul style="list-style-type: none"> ● May be station trouble. ● Check if SPEAKERS ON/OFF function (page 31) is properly set. 	<ul style="list-style-type: none"> ● Try another channel. ● Adjust VOLUME.
● Poor sound, picture OK	<ul style="list-style-type: none"> ● May be station trouble. ● Check antenna connections. ● May be local interference from appliance. 	<ul style="list-style-type: none"> ● Try another channel. ● Adjust VOLUME. ● Adjust BASS, TREBLE, or BALANCE control. ● Re-orient antenna.
<ul style="list-style-type: none"> ● Poor picture, sound OK ● Snowy picture ● Lines in picture ● Distorted picture ● Weak picture 	<ul style="list-style-type: none"> ● May be local interference from appliance. ● Check antenna connections. ● Check antenna for broken wires. ● May be station trouble. 	<ul style="list-style-type: none"> ● Try another channel. ● Adjust BRIGHTNESS. ● Adjust CONTRAST. ● Adjust SHARPNESS. ● Re-orient antenna.
● Poor reception of broadcast channels	<ul style="list-style-type: none"> ● Check antenna connections. ● Check antenna for broken wires. ● If VCR is connected, check TV/VCR switch. 	<ul style="list-style-type: none"> ● Try another channel. ● Re-orient antenna.
● No UHF, VHF OK	<ul style="list-style-type: none"> ● Be sure TV/CABLE function (page 13) is in "TV" mode. 	
● Unable to select a certain channel	<ul style="list-style-type: none"> ● That channel may be locked out with CH LOCK function (page 26), or erased with the ADD/ERASE function (page 14). 	
● Multiple images (ghosts)	<ul style="list-style-type: none"> ● May be station trouble. ● Check antenna connections. 	<ul style="list-style-type: none"> ● Try another channel. ● Re-orient antenna.
● Poor color or No color	<ul style="list-style-type: none"> ● May be station trouble. ● Check antenna connections. ● Check antenna for broken wires. ● May be local interference from appliance. ● Check if station is broadcasting in color. ● If you change the direction of the TV while the TV is activated, the picture may suffer from color shading. If so, turn off the TV and allow to cool for about 30 minutes, then turn on the TV again. The picture should improve. 	<ul style="list-style-type: none"> ● Try another channel. ● Re-orient antenna. ● Adjust TINT. ● Adjust COLOR.
● No stereo or SAP sound from a known MTS broadcast	<ul style="list-style-type: none"> ● Check if MTS function is properly set. 	
● Remote Control does not work	<ul style="list-style-type: none"> ● Check if TV-CABLE-VCR switch is properly set. ● Be sure power cord is plugged in. ● Check battery in Remote Control. 	<ul style="list-style-type: none"> ● Change batteries.

Limited United States Warranty

Toshiba America Consumer Products, Inc. ("TACP") and Toshiba Hawaii Inc. ("THI") make the following limited warranties. These limited warranties extend to the original consumer purchaser or any person receiving this set as a gift from the original consumer purchaser and to no other purchaser or transferee.

Limited One (1) Year Warranty

TACP and THI warrant this product and its parts against defects in materials or workmanship for a period of one (1) year after the date of original retail purchase. During this period, TACP and THI will repair a defective product or part, without charge to you. "Authorized TACP/THI service station personnel will come to your home when warranty service is required. Depending on the type of repair required, the service will either be performed in your home or the set will be taken to the authorized TACP/THI service station for repair and returned to your home at no cost to you."

Limited Two (2) Year Warranty of Picture Tube

TACP and THI further warrant the picture tube in this product against defects in materials or workmanship for a period of two (2) years after the date of original retail purchase. During this period, TACP and THI will replace a defective picture tube without charge to you, except that if a defective picture tube is replaced after one (1) year from the date of the original retail purchase, you pay labor charges involved in the replacement.

Owner's Manual and Registration Card

You should read this owner's manual thoroughly before operating this product. You should also insure that your name and address are on file as owner of a TACP/THI product by completing and mailing the enclosed registration card within ten days after you, or the person who has given you this product as a gift, purchased this product. This is one way to enable TACP/THI to provide you with

better customer service and improved products. Failure to return the card will not affect your rights under this warranty so long as you retain other proof of purchase such as a bill of sale.

Your Responsibility

The above warranties are subject to the following conditions:

- (1) You must retain your bill of sale or provide other proof of purchase.
- (2) All warranty servicing of this product must be made by an Authorized TACP/THI Service Station.
- (3) **These warranties are effective only if the product is purchased and operated in the U.S.A.**
- (4) Labor service charges for set installation, set up, adjustment of customer controls and installation or repair of antenna systems are not covered by this warranty. Reception problems caused by inadequate antenna systems are your responsibility.
- (5) Warranties extend only to defects in materials or workmanship as limited above and do not extend to any product or parts which have been lost or discarded by you or to damage to products or parts caused by misuse, accident, damage caused by Acts of God, such as lightning or fluctuations in electric power, improper installation, improper maintenance or use in violation of instructions furnished by us; or to units which have been altered or modified without authorization of TACP/THI or to damage to products or parts thereof which have had the serial number removed, altered, defaced or rendered illegible.

Step-By-Step Procedures – How to Obtain Warranty Service

If, after following all of the operating instructions in this manual and checking the section "BEFORE CALLING SERVICE PERSONNEL", you find that service is needed;

- (1) Contact one of the TACP/THI Service Centers listed below for warranty service or call the TACP toll free number **800-631-3811** within thirty (30) days after you find a defective product or part to find the nearest TOSHIBA Authorized Service Station or any authorized TOSHIBA dealer.
- (2) Please present your bill of sale or other proof to the Authorized Service Station. "Authorized TACP/THI service station personnel will come to your home when warranty service is required. Depending on the type of repair required, the service will either be performed in your home or the set will be taken to the authorized TACP/THI service station for repair and returned to your home at no cost to you."
- (3) If you have any question about service, please contact one of the following TACP/THI Service Centers:

IN THE CONTINENTAL UNITED STATES
Should your unit require service, Call



NORTHEAST	MIDWEST	WEST	SOUTHEAST	SOUTHWEST	HAWAII
82 Totowa Road, Wayne, New Jersey 07470	1010 Johnson Drive, Buffalo Grove, Ill 60089-6900	5490 E. Francis St., Ontario, California 91761	6115 Jimmy Carter Blvd., Suite C2, Norcross, Georgia 30071-4607	1421 Champion Drive Suite 304, Carrollton, Texas 75006	327 Kamakee Street, Honolulu, Hawaii 96814

All warranties implied by state law, including the implied warranties of merchantability and fitness for a particular purpose, are expressly limited to the duration of the limited warranties set forth above. With the exception of any warranties implied by state law as hereby limited, the foregoing warranty is exclusive and in lieu of all other warranties, guarantees, agreements and similar obligations of manufacturer or seller with respect to the repair or replacement of any product or parts. In no event shall TACP or THI be liable for consequential or incidental damages.

No person, agent, distributor, dealer or company is authorized to change, modify or extend the terms of these warranties in any manner whatsoever. The time within which action must be commenced to enforce any obligation of TACP or THI arising under this warranty or under any statute, or law of the United States or any state thereof, is hereby limited to 90 days from the date you discover or should have discovered, the defect. This limitation does not apply to implied warranties arising under state law.

This warranty gives you specific legal rights and you may also have other rights which may vary from state to state. Some states do not allow limitation on how long an implied warranty lasts, when an action may be brought, or the exclusion or limitation of incidental or consequential damages, so the above provisions may not apply to you.



ATTENTION CANADIAN CONSUMERS:

Canadian consumers are requested to complete the special Canadian "Warranty Registration Form" enclosed, and forward this completed form with a copy of bill of sale to TOSHIBA OF CANADA to "Register and Validate" their warranty.

TOSHIBA AMERICA CONSUMER PRODUCTS, INC.

HEAD OFFICE/82 TOTOWA ROAD, WAYNE, NEW JERSEY 07470

FACTORY SERVICE CENTERS/NORTHEAST: 82 TOTOWA ROAD, WAYNE, NEW JERSEY 07470

MIDWEST: 1010 JOHNSON DRIVE, BUFFALO GROVE, ILLINOIS 60089-6900

WEST: 5490 E. FRANCIS ST., ONTARIO, CA 91761

SOUTHWEST: 1421 CHAMPION DRIVE, SUITE 304 CARROLLTON, TEXAS 75006

SOUTHEAST: 6115 JIMMY CARTER BLVD., SUITE C2, NORCROSS, GA 30071-4607

TOSHIBA HAWAII, INC.

HEAD OFFICE/327 KAMAKEE STREET, HONOLULU, HAWAII 96814, U.S.A.

TOSHIBA OF CANADA LTD.

HEAD OFFICE/191 McNABB STREET, MARKHAM, ONTARIO, L3R 8H2, CANADA TEL: (905) 470-5400

SERVICE CENTERS/TORONTO: 191 McNABB STREET, MARKHAM, ONTARIO, L3R 8H2, CANADA TEL: (905) 470-5400

MONTREAL: 1643, NORTH SERVICE RD., TRANS-CANADA HIGHWAY, DORVAL QUEBEC, H9P 1J1, CANADA

TEL: (514) 332-6860

VANCOUVER: 3870 JACOMBS ROAD, RICHMOND, B.C., V6V 1Y6, CANADA TEL: (604) 270-8481

MANUFACTURED BY

TOSHIBA AMERICA CONSUMER PRODUCTS, INC.

PRINTED IN USA

(96-07)L

TOSHIBA

23562785